

## NRC Publications Archive Archives des publications du CNRC

### Summer shading performance of awnings at the Canadian Center for Housing Technology

Gusdorf, J.; Armstrong, M. M.; Szadkowski, F.; Sager, J.

For the publisher's version, please access the DOI link below./ Pour consulter la version de l'éditeur, utilisez le lien DOI ci-dessous.

#### **Publisher's version / Version de l'éditeur:**

<https://doi.org/10.4224/20374026>

*Client Report (National Research Council Canada. Institute for Research in Construction); no. B-6041.1, 2011-03-24*

#### **NRC Publications Archive Record / Notice des Archives des publications du CNRC :**

<https://nrc-publications.canada.ca/eng/view/object/?id=198ad5d0-7ee4-4e0c-9031-eb7906b7985>

<https://publications-cnrc.canada.ca/fra/voir/objet/?id=198ad5d0-7ee4-4e0c-9031-eb7906b79857>

Access and use of this website and the material on it are subject to the Terms and Conditions set forth at

<https://nrc-publications.canada.ca/eng/copyright>

READ THESE TERMS AND CONDITIONS CAREFULLY BEFORE USING THIS WEBSITE.

L'accès à ce site Web et l'utilisation de son contenu sont assujettis aux conditions présentées dans le site

<https://publications-cnrc.canada.ca/fra/droits>

LISEZ CES CONDITIONS ATTENTIVEMENT AVANT D'UTILISER CE SITE WEB.

**Questions?** Contact the NRC Publications Archive team at [PublicationsArchive-ArchivesPublications@nrc-cnrc.gc.ca](mailto:PublicationsArchive-ArchivesPublications@nrc-cnrc.gc.ca). If you wish to email the authors directly, please see the first page of the publication for their contact information.

**Vous avez des questions?** Nous pouvons vous aider. Pour communiquer directement avec un auteur, consultez la première page de la revue dans laquelle son article a été publié afin de trouver ses coordonnées. Si vous n'arrivez pas à les repérer, communiquez avec nous à [PublicationsArchive-ArchivesPublications@nrc-cnrc.gc.ca](mailto:PublicationsArchive-ArchivesPublications@nrc-cnrc.gc.ca).



**Canadian Centre  
for Housing Technology**

**Centre canadien des  
technologies résidentielles**

---

**Summer Shading Performance of Awnings at the  
Canadian Centre for Housing Technology**

**Contract: B-6041**

**Report B-6041.1**

**John Gusdorf  
Marianne Armstrong  
Frank Szadkowski  
Jeremy Sager**

**FINAL REPORT**

**March 24, 2011**

# Summer Shading Performance of Awnings at the Canadian Centre for Housing Technology

Author \_\_\_\_\_  
Mr. J.Gusdorf (NRCan)

Author \_\_\_\_\_  
Ms. M.M. Armstrong

Author \_\_\_\_\_  
Mr. F. Szadkowski (NRCan)

Author \_\_\_\_\_  
Mr. J. Sager (NRCan)

Quality Assurance \_\_\_\_\_  
Mr. M.C. Swinton

Approved \_\_\_\_\_  
Dr. T. Nightingale  
Director, Indoor Environment

Report No: B-6041.1  
Report Date: 24 March 2010  
Contract No: B-6041  
Reference: Agreement dated 29 Jul 2010  
Program: Indoor Environment

33 pages

Copy No. 3 of 9 copies

This report may not be reproduced in whole or in part without the written consent of both the client and the National Research Council Canada

## **The Canadian Centre for Housing Technology (CCHT)**

Built in 1998, the Canadian Centre for Housing Technology (CCHT) is jointly operated by the National Research Council, Natural Resources Canada, and Canada Mortgage and Housing Corporation. CCHT's mission is to accelerate the development of new technologies and their acceptance in the marketplace.

The Canadian Centre for Housing Technology features twin research houses to evaluate the whole-house performance of new technologies in side-by-side testing. The twin houses offer an intensively monitored real-world environment with simulated occupancy to assess the performance of the residential energy technologies in secure premises. This facility was designed to provide a stepping-stone for manufacturers and developers to test innovative technologies prior to full field trials in occupied houses.

As well, CCHT has an information centre, the InfoCentre, which features a showroom, high-tech meeting room, and the CMHC award winning FlexHouse™ design, shown at CCHT as a demo home. The InfoCentre also features functioning state-of-the art equipment, and demo solar photovoltaic panels.



HOME TO CANADIANS  
Canada



Natural Resources  
Canada

Ressources naturelles  
Canada

**NRC · CNRC**



## **Acknowledgements**

Thanks are extended to Dr. Aziz Laouadi and to Ken Ruest for their valuable feedback and guidance. The funding for this project was provided by Canada Mortgage and Housing Corporation (CMHC), Natural Resources Canada (NRCan) and the National Research Council of Canada (NRC).

*Final Report: Summer Performance of Awnings at the CCHT*

# Table of Contents

<b>Introduction</b> .....	1
<b>The CCHT</b> .....	2
<b>The Technology</b> .....	3
<b>Objective</b> .....	3
<b>The Experiment</b> .....	4
<b>Benchmarking</b> .....	5
<b>Testing</b> .....	6
<b>Results</b> .....	6
<b>Energy Use</b> .....	6
<b>A/C Condenser Unit (compressor + outdoor fan)</b> .....	6
<i>Benchmarking</i> .....	6
<i>Testing</i> .....	8
<b>Furnace Fan + A/C Condenser</b> .....	8
<i>Benchmarking</i> .....	8
<i>Testing</i> .....	9
<b>Annual Savings</b> .....	11
<b>Temperatures</b> .....	11
<b>Light Levels</b> .....	15
<b>Comparisons with Other Projects</b> .....	18
<b>Discussion</b> .....	19
<b>Conclusions &amp; Recommendations</b> .....	20
<b>References</b> .....	22
Appendix I: Window & Awning Geometry.....	23
Appendix II: Simulated Occupancy Schedule .....	27
Appendix III: Additional Graphs of Maximum Temperatures .....	28
Appendix IV: Temperature Frequency & Probability Graphs.....	31

*Final Report: Summer Performance of Awnings at the CCHT*



## **Introduction**

Solar energy entering the windows of a house can provide significant passive solar heating. Managing these solar gains in all seasons is important to minimizing energy use for space heating and cooling, particularly as house performance approaches net-zero energy. During the heating season, maximizing solar gains minimizes energy use, but can result in occasional overheating, especially in very energy-efficient houses with large areas of south or west facing windows. During the cooling season, solar gains should be minimized to reduce cooling loads and to avoid overheating.

It is often assumed that fixed overhangs above south facing windows will allow for passive heating by the low winter sun, while preventing overheating by blocking the high summer sun (CHBA, pp. 36-37). However, recent modelling work done by Natural Resources Canada's CanmetENERGY has shown that there is no net benefit to any configuration of fixed overhangs. This is because the overhangs block potentially useful solar energy in the Spring shoulder seasons ( March and April), and allow the sun to overheat a house in August and September.

Interior shading devices such as blinds, shades or curtains are found in most houses, and can be easily adjusted by occupants, but a recent study at the Canadian Centre for Housing Technology (CCHT) showed that "typical interior blinds . . . are not particularly energy-efficient nor cost-effective compared to un-shaded windows" (Laouadi, p.13). The same study goes on to show that:

Exterior insulating rollshutters and close-weave screens are the most effective shading devices to reduce the house heating and cooling energy use, the on-peak cooling power demand, the risk of moisture condensation on the interior surfaces of windows, and the thermal discomfort conditions near windows.

.....

When compared with typical interior blinds of old houses with conventional double clear windows, rollshutters may reduce the annual heating energy use by 7%, the cooling energy use by more than 40%, and the on-peak cooling power demand by 18% to 42% (30% on average). For R-2000 houses with double clear low-e windows, rollshutters may reduce the annual heating energy use by 6%, the cooling energy use by more than 53%, and the on-peak cooling power demand by 29% to 48% (39% on average) (*Ibid*).

However, rollshutters and exterior screens are unconventional in appearance (see Figure 1), and block some or all daylight when deployed. The effective operation of rollshutters also relies on proper and consistent use by the occupant.

Awnings were common on houses in the past, and may be more acceptable to occupants. Awnings will not reduce the risk of moisture condensation or cold conditions near windows, nor will they reduce heating loads, except as they allow for larger south-facing windows areas.



Figure 1. Rollshutters on the north side of a CCHT house.

(They could increase heating loads if not retracted during the heating season). However, they should be able to reduce cooling energy and overheating during the heating season, while maximizing useful solar gains. This study was designed to directly measure reduced cooling energy due to awnings on south windows. It also compares temperatures and light levels (illuminance) with and without the awnings.

## **The CCHT**

The Canadian Centre for Housing Technology (CCHT) is a facility designed for evaluating whole-house performance of residential technologies. It includes two highly instrumented, identical, unoccupied houses. Each is two storeys with 223 m<sup>2</sup> (2,400 ft<sup>2</sup>) of floor area, not counting the full basements. Occupancy is simulated by computer controlled operation of lights and appliances, use of hot water, and generation of heat to simulate the presence of occupants. Repeated testing under identical conditions (benchmarking) has shown that the two houses use almost exactly the same amounts of energy for space heating, air conditioning, hot water and utilities. For more information see [www.ccht-cctr.gc.ca](http://www.ccht-cctr.gc.ca).

The CCHT houses are ideal locations for testing shading devices because having two identical houses at the same site allows the effects of a relatively small change in one of them to be clearly shown in the collected data, rather than based on an analysis of cooling loads derived from outdoor temperatures, wind speeds and solar radiation.



Figure 2. The Awnings on the Experimental House, photographed close to Solar Noon.

## **The Technology**

The shading devices that were tested in this project were standard commercially available canvas awnings. They were mounted on the three largest south facing windows of one of the CCHT houses, the Experimental House, as shown in Figure 2. These windows face very close to true south. The awnings are manually operated, allowing users to deploy them when shading is desired, and to retract them to allow maximum daylighting and solar gains at other times. Figure 3 shows the profile of the deployed awning on the ground floor window. All three windows and their awning geometry are shown in Appendix I.

## **Objective**

The main objective of this project was to determine the amount of cooling energy that the awnings would save. Secondary objectives were to:

*Final Report: Summer Performance of Awnings at the CCHT*

- § compare temperatures in the two houses, both in rooms that had awnings in one of the houses, and in those that did not, and
- § compare light levels (illuminance) in the rooms that had awnings in one of the houses.

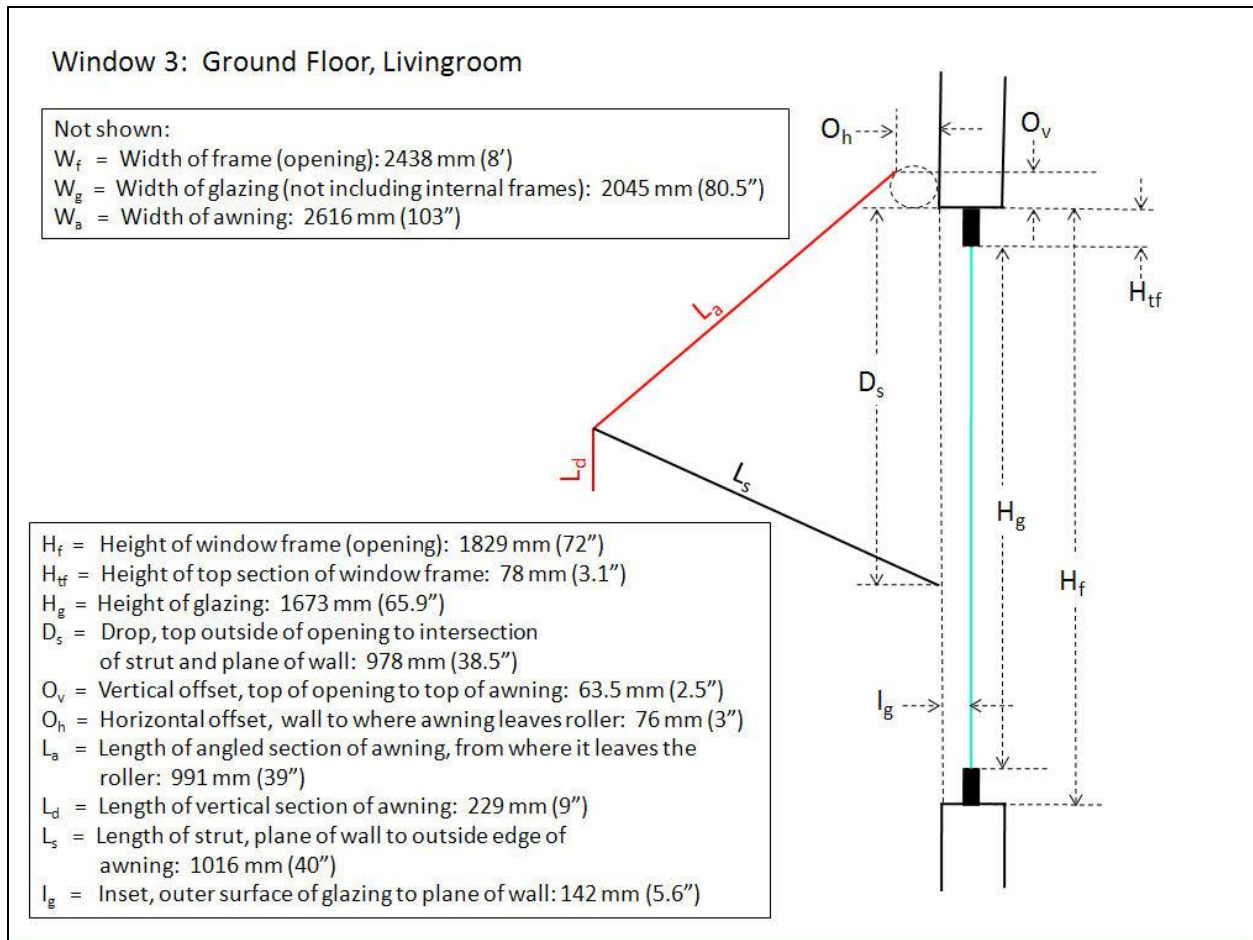

Figure 3. Schematic profile of Window 3, NTS.

## The Experiment

As with all side-by-side testing at the CCHT, the experiment consisted of two phases: The first was benchmarking, in which the two houses were run with identical internal conditions, and no awnings on either house. This determined how similar the amounts of energy used for air conditioning were under a range of weather conditions, and provided the basis of comparison. The second phase was the experiment, in which the awnings were installed on the experimental house, while the control house continued to operate without awnings. Internal conditions in both houses were the same as during benchmarking, and are shown in Table 1.

*Final Report: Summer Performance of Awnings at the CCHT*

	<b>System</b>	<b>Setting</b>
1	Air circulation	The fan of a high efficiency condensing gas furnace provides low speed continuous circulation and high speed airflow for cooling
2	Air Conditioner	2 ton (7.03 kW), 13 SEER
3	Thermostat Set-point	24°C
4	HRV	Low speed continuous (30.7 L/s, 65 cfm)
5	Windows	Closed & locked
6	Simulated Occupancy	Standard Schedule
7	Humidifier	Off

Table 1. Operating Conditions for Benchmark and Experiment, both houses.

Simulated occupancy includes light bulbs that simulate the heat from humans in various locations, operation of lights and major appliances, and hot water draws. The complete schedule is shown in Appendix II.

## **Benchmarking**

Benchmarking took place on the following 35 days in 2010:

- 18 May - 25 May
- 12 June - 14 June
- 16 June - 17 June
- 19 June - 27 June
- 1 July - 4 July
- 6 July - 11 July
- 7 August
- 15 August

Outdoor temperature varied from a minimum of 11.6 C on 7 August, to a maximum of 36.8 C on 8 July. Daily amounts of global solar radiation, as measured by a precision spectral

## *Final Report: Summer Performance of Awnings at the CCHT*

pyranometer mounted on a horizontal plane above the house roof, varied from 5,081 kJ/m<sup>2</sup> on 16 June to 28,325 on 21 May.

### **Testing**

Testing took place on the following 24 days in 2010:

- 21 August - 27 August
- 29 August - 10 September
- 13 and 14 September
- 18 and 19 September

Outdoor temperature varied from a low of 7.1 C on 18 September to a high of 33.6 C on 31 August. Daily amounts of global solar radiation ranged from 3,689 kJ/m<sup>2</sup> on 22 August to 22,505 kJ/m<sup>2</sup> on 29 August.

Thus, the benchmark and testing periods included similar ranges of temperatures and solar radiation.

### **Results**

#### **Energy Use**

##### **A/C Condenser Unit (compressor + outdoor fan)**

##### ***Benchmarking***

During benchmarking, daily energy use by the air conditioner compressors (A/C) in the two houses was similar. In the control house, it varied from 0.328 kWh to 32.669 kWh, and averaged 11.415 kWh. In the experiment house, it varied from 0.487 to 34.621, and averaged 12.279 kWh. Thus, when operated under identical conditions spanning a wide range of weather, A/C energy use in the experiment house averaged 7.6% more than in the control house.

In Figure 4, each point represents one day of benchmarking or testing. Each point's x-coordinate is equal to the number of kWh used in the control house, and its y-coordinate is equal to the number used in the experiment house. A day during which both houses used the same amount would fall on the 45° line. Thus, if the two houses and their A/C units were perfectly matched, then all of the benchmark points (red diamonds), and their linear regression, would line on the 45° line. As can be seen in Figure 4, all of the benchmark points and their regression lie above the 45° line and the gap gets larger for larger values, thereby demonstrating that the experiment house used more A/C energy, and that the difference got larger with larger cooling loads. Thus, the benchmark is not perfect, but it is close enough to be useful for comparisons with test results. The relationship between the two houses is almost perfectly linear, as shown by the r<sup>2</sup> value of just over 0.999.

Final Report: Summer Performance of Awnings at the CCHT

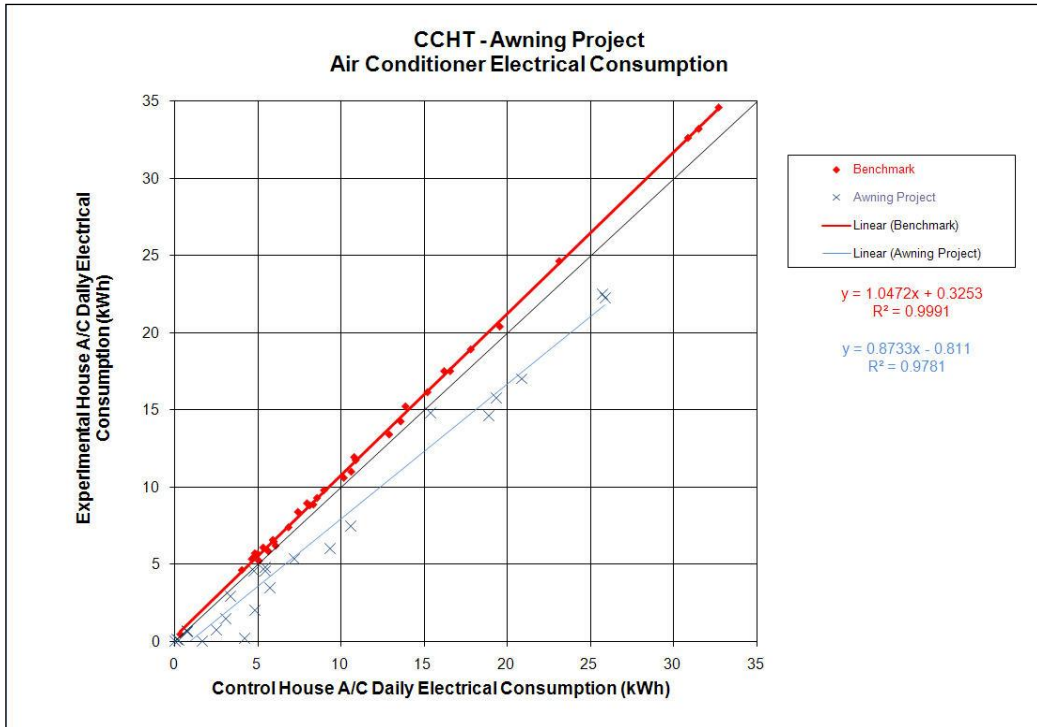

Figure 4. A/C Energy Use during Benchmarking and Testing.

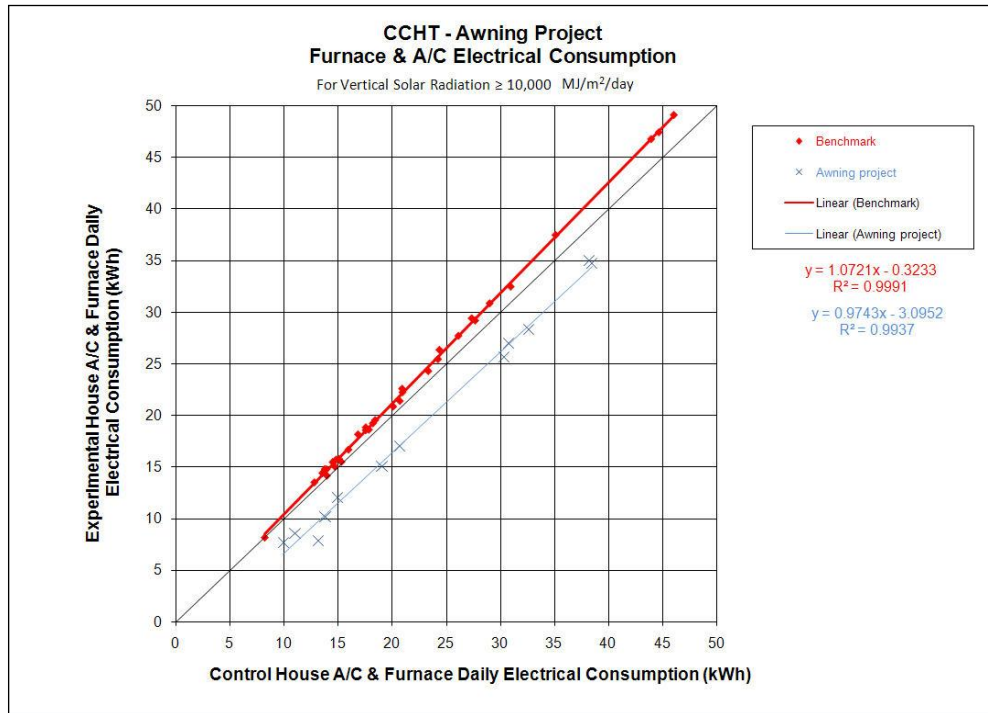

Figure 5. A/C Energy Use, High Vertical Solar Radiation in Testing.

## *Final Report: Summer Performance of Awnings at the CCHT*

### **Testing**

The blue X's in Figure 4 represent days of testing with the awnings installed on the experiment house. All but one of these points lie below the 45° line, showing that the A/C in the experiment house used less energy than the one in the control house. (The exception is 22 August when the experiment house used 0.148 kWh and the control used 0.130). The energy saving due to the awnings is represented by the vertical distance between the benchmark and testing regression lines, and increases as cooling loads increase, due mainly to solar radiation.

During testing, energy use by the A/C compressor in the control house varied from 0.023 to 25.871 kWh, and averaged 8.170, while the experiment house varied from zero to 22.486, and averaged 6.324 kWh. Thus, A/C energy use in the experiment house went from 7.6% more than the control house during benchmarking to 22.6% less during testing, an apparent net reduction of 30%. Savings can be determined more accurately by calculating the vertical distance between each of the test points and the benchmark regression in Figure 4. The result is an average daily saving of 2.557 kWh or 28.8% due to the awnings.

During testing, the vertical solar radiation on the south walls of the houses varied from 1,597 to 17,853 kJ/m<sup>2</sup>, and averaged 9,956. As would be expected, energy savings were greatest when there was more solar radiation. This can be shown in two ways. First, Figure 5 is the same as Figure 4, except that instead of showing all 24 days of testing, only the 11 days with solar radiation of 10,000 kJ/m<sup>2</sup> or more are included. This reduces the scatter in the test points considerably, increasing their  $r^2$  from 0.9781 to 0.9941. Most of the eliminated points are at the low end, as would be expected since days with less sun generally have smaller cooling loads. The one eliminated midway point (at about 15 kWh) is for 2 September, when the outdoor temperature reached 30.5 C, and solar radiation was just below the cut off at 9,158 kJ/m<sup>2</sup>. Second, Figure 6 plots the energy savings against solar radiation for each day with awnings, and indicates that savings increase exponentially with increased radiation.

### **Furnace Fan + A/C Condenser**

#### ***Benchmarking***

Energy use by the furnace fan increases with increasing use of the A/C because the fan switches from low to high speed when the A/C is on. During benchmarking, daily energy use for both the compressor and fan in the control house ranged from 8.242 to 46.042 kWh, and averaged 21.507. In the experiment house it ranged from 8.196 to 49.094 kWh, and averaged 22.734. Thus, the experiment house averaged 5.7% higher than the control. This excess is smaller than the 7.6% for the A/C only because the fan energy is more equal in the two houses. In the control house, energy for the fan alone averaged 10.092 kWh/day, and in the experiment house it averaged 10.455, or 3.5% more. Thus, as with the A/C only, the benchmark is less than perfect, but has an  $r^2$  of over 0.991, as shown in Figure 7.

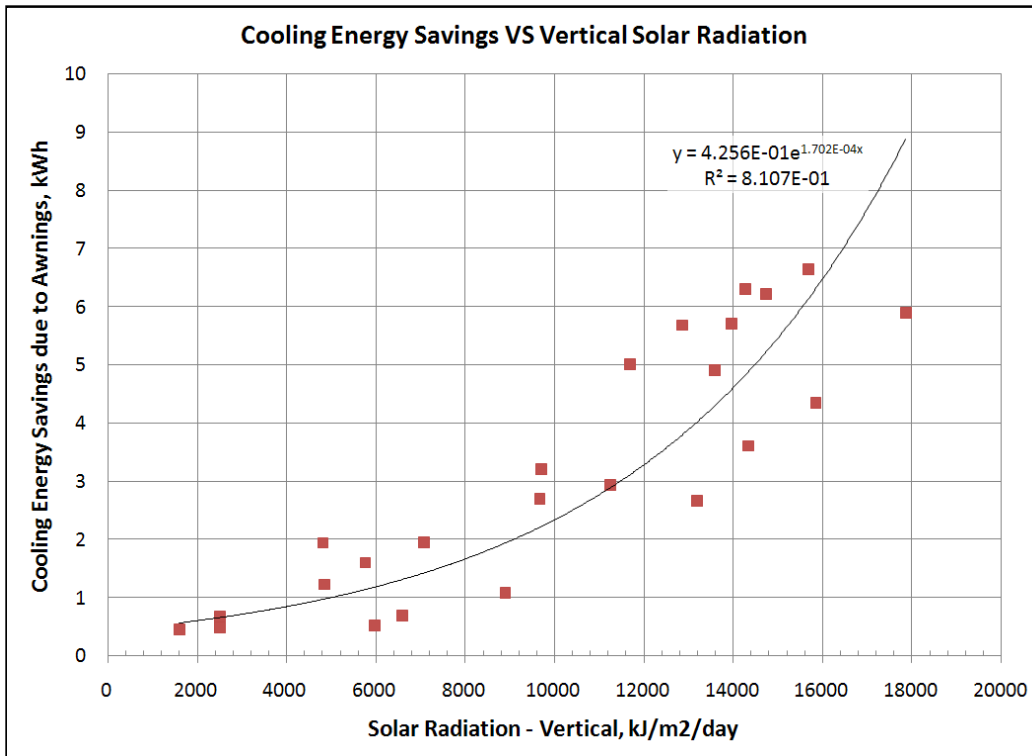

Figure 6. Energy Saving vs. Solar Radiation.

### Testing

During testing, daily energy use for the compressor and fan in the control house varied from 7.870 to 38.468 kWh, and averaged 17.661. In the experiment house, it ranged from 7.624 to 34.960 kWh, and averaged 15.425, or 12.7% less than the control. The difference between the benchmark and test shows an apparent net energy savings for both the condensing unit and the furnace fan of 18.3% (12.7% + 5.7%). The more accurate determination of savings based on the vertical distance between the test points and the benchmark regression line is an average daily saving of 3.186 kWh or 16.7%.

Figures 7 & 8 show the combined energy use of the A/C condenser unit and the furnace fan. Figure 7 includes all 24 days of awning testing, while Figure 8 shows only the 11 days with vertical solar radiation greater than or equal to 10,000 kJ/m<sup>2</sup>. As in Figures 4 & 5, eliminating the days with low solar radiation significantly reduces scatter and improves the  $r^2$  of the test results.

Final Report: Summer Performance of Awnings at the CCHT

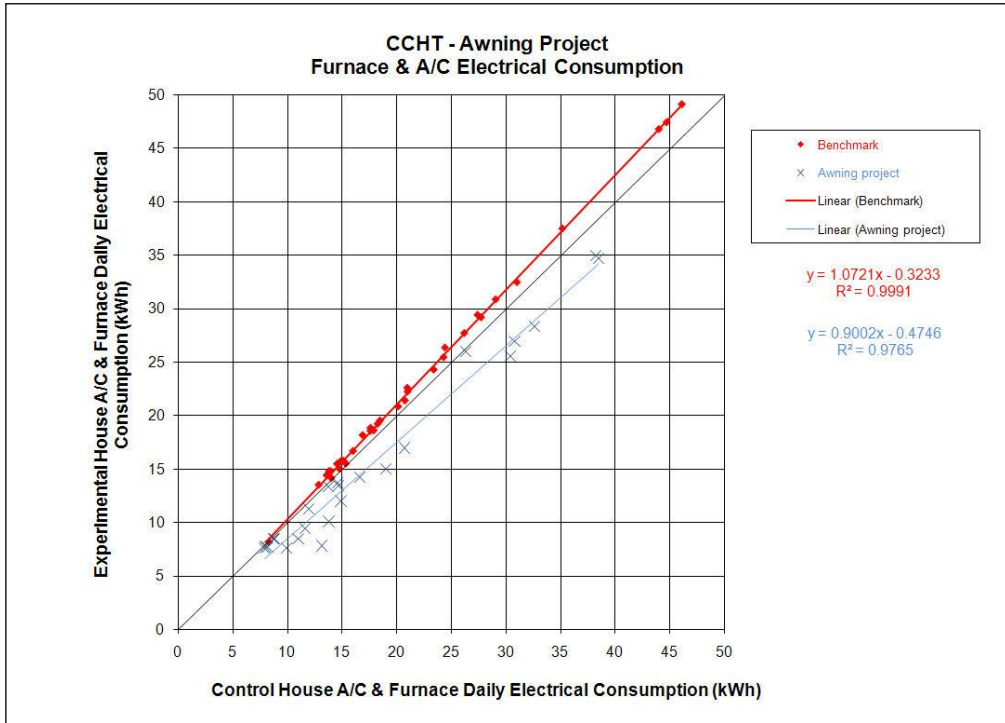

Figure 7. A/C & Fan Energy Use during Benchmarking and Testing.

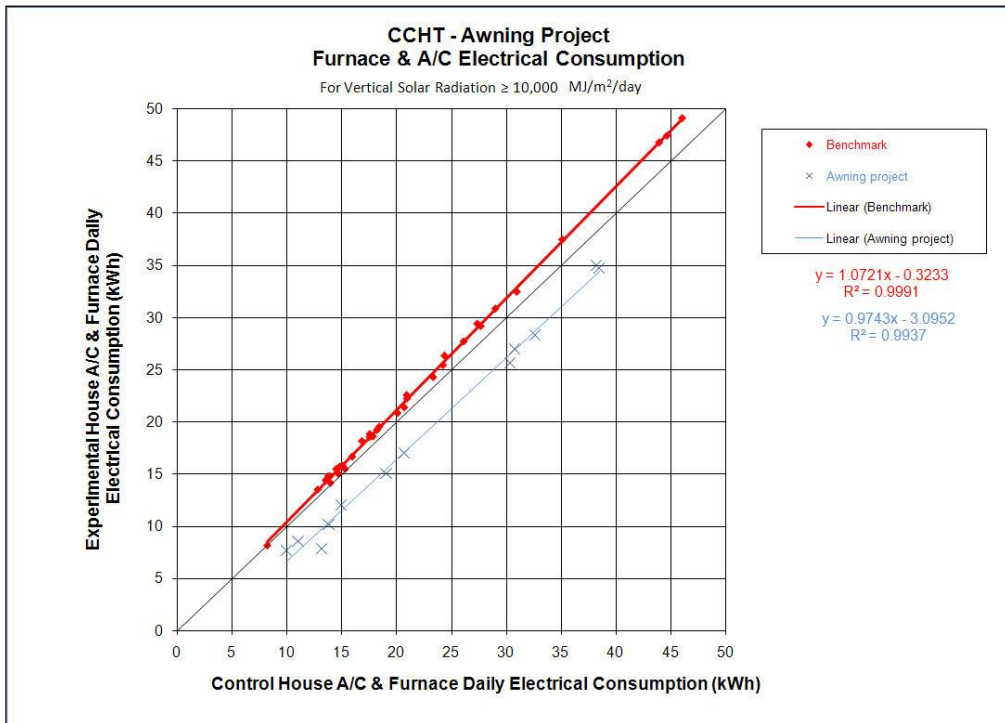

Figure 8. A/C & Fan Energy Use, High Vertical Solar Radiation in Testing.

## *Final Report: Summer Performance of Awnings at the CCHT*

### **Annual Savings**

The 2010 cooling season for the CCHT houses began on 17 May and lasted 127 days, ending with 20 September. The A/C compressor savings due to the awnings averaged 2.557 kWh/day, so projected to the full 127 day season, the total savings would be 325 kWh. The total A/C and fan savings averaged 3.186 kWh/day, so for the cooling season the total savings would have been 405 kWh. A more accurate calculation of total A/C and fan savings is based on a two-factor regression of daily savings versus vertical solar radiation on the south wall of the houses, and average outdoor temperature. The result has an  $r^2$  of 0.9240, meaning that most of the savings are accounted for by the solar radiation and temperature. The regression factors are then used to calculate the savings for each day of the cooling season as:

$$\text{Saving (kWh)} = \text{Solar (kJ/m}^2\text{/day)} * 0.000348737 + T(\text{C}) * 0.184775605 - 3.995825498.$$

The result is a total seasonal saving of 401 kWh, or 15% of the total amount used in the control house for the season.

The CCHT houses were operated with the windows closed and the A/C under thermostat control throughout the cooling season. Occupants of similar houses who open and close windows to control temperatures, and only use the A/C when necessary would incur smaller cooling loads that could lead to smaller savings. On the other hand, when the A/C is not in use, the awnings would keep indoor temperatures lower, resulting in less A/C use. So awnings should still save cooling energy, although it is not possible to estimate the amount here.

### **Temperatures**

The awnings cause temperatures to be lower, both in the rooms with awnings and those without. Figures 9 & 10 show the layout of the first and second floors of the CCHT houses. The rooms with the awnings in the experiment house are the living room on the first floor, and the master bedroom and bedroom 2 on the second floor.

Figure 11 shows the maximum daily temperatures in the master bedroom for each day of benchmarking and testing. During benchmarking, the maximum temperatures are generally slightly lower in the experiment house, and the differences are larger for lower temperatures. During most days, the maximum temperatures are above the 24 °C set-point, indicated by the heavy gridlines in the figure. During testing with awnings, the maximum temperatures in the experiment house are significantly lower than in the control house, and the majority (17 of 24) are below the set-point. The average maximum temperature in the control house is 24.8 °C, while in the experiment house it is 23.7 °C. If one compensates for the lower experiment house temperatures during benchmarking, then the expected experiment house average is 24.7 °C, indicating that the awnings keep the maximum temperatures in the experiment house 1.0 °C cooler on average. The largest difference was 2.8 °C on 19 September when the experiment house reached 22.9 °C and the expected experiment house maximum was 25.7 °C.

Final Report: Summer Performance of Awnings at the CCHT

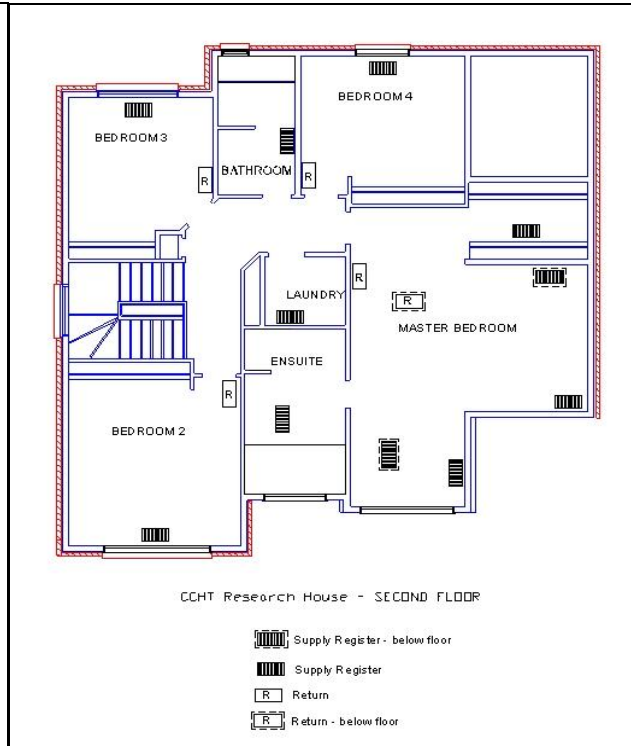
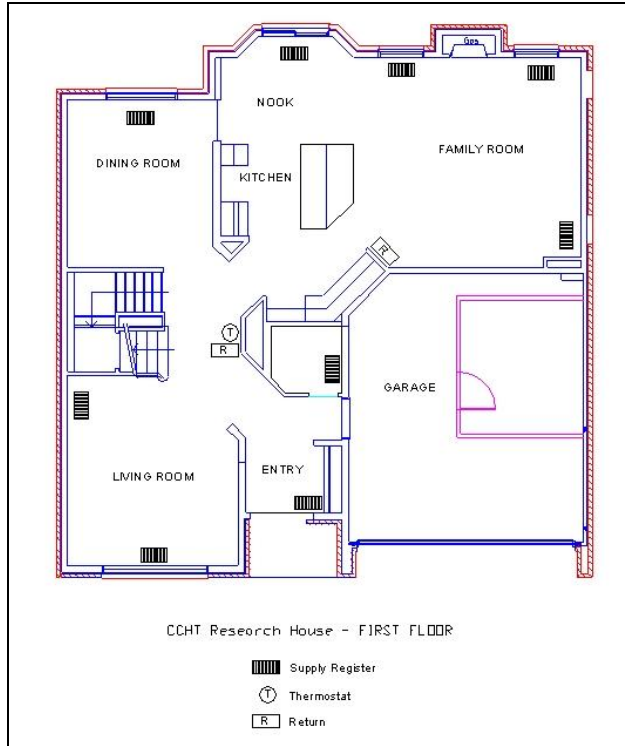

Figure 9. Layout, 1<sup>st</sup> Floor of CCHT Houses.

Figure 10. Layout, 2<sup>nd</sup> Floor of CCHT Houses.

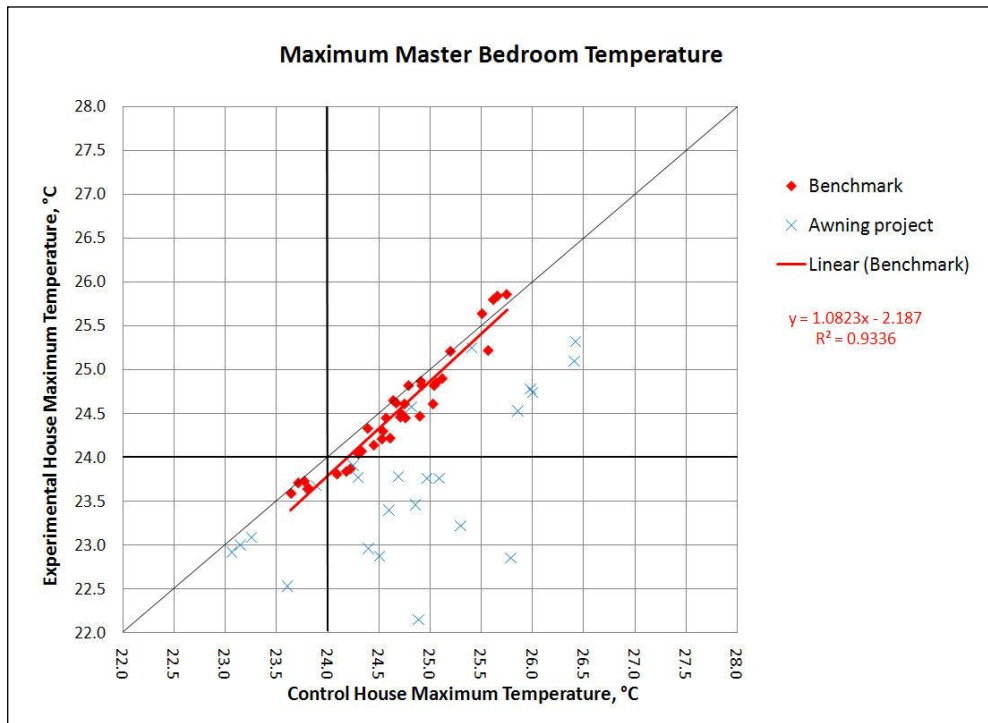

Figure 11. Maximum Daily Temperatures, Master Bedroom.

Final Report: Summer Performance of Awnings at the CCHT

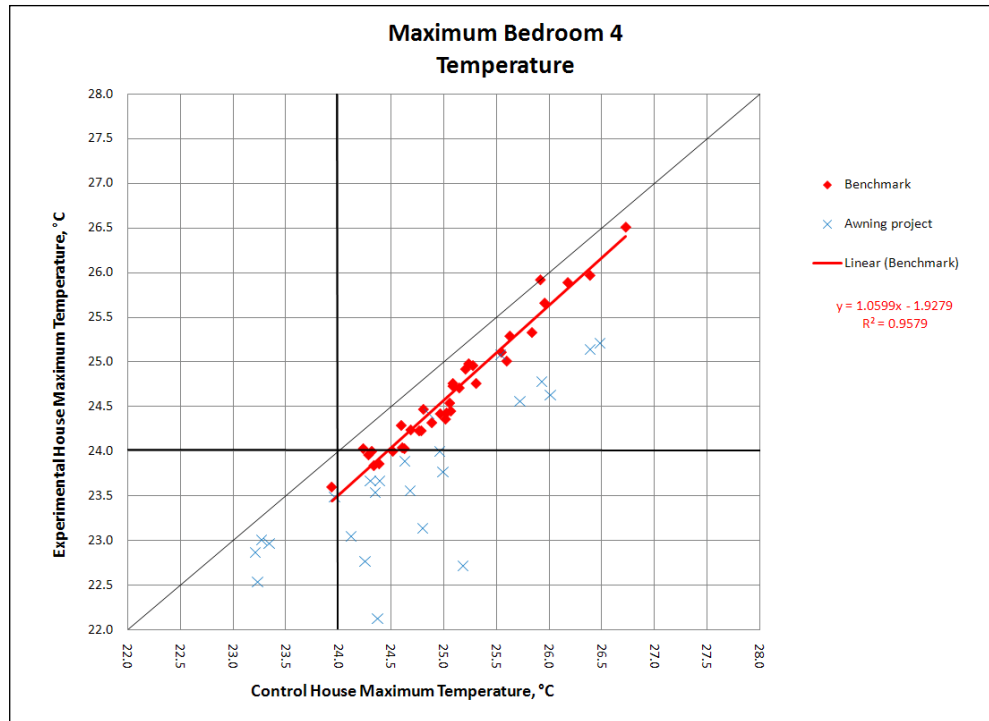

Figure 12. Maximum Daily Temperatures, Bedroom 4.

Figure 12 shows the maximum daily temperatures in bedroom 4, a room without awnings on the second floor. The pattern is very similar to the Figure 11, showing that the awnings' temperature effects are not limited to the rooms with awnings. Appendix III has graphs for bedroom 2 (with awnings), and the ensuite bath, bedroom 3, and the second floor bathroom (no awnings). Appendix IV contains graphs of temperature bins and probabilities based on all hourly temperatures, rather than maximums. These also show that the awnings generally reduce temperatures, both in rooms with and without them, especially on the second floor. Cooler temperatures in rooms without awnings are presumably due to circulation of air by the furnace fan. As mentioned, the fan runs in low speed continuously, and switches to high speed when the A/C is on.

On the ground floor, the patterns are somewhat different, but still show reductions by the awnings. Figure 13 shows the maximum daily temperatures for the living room (with awnings). During the benchmark, the temperatures in the two houses are much more similar than on the second floor, with the control house averaging only 0.1 °C warmer. Most of the daily maximums are closer to the set-point. This is to be expected since the thermostat is located just outside the living room, as shown in Figure 9. However, the difference between the actual and expected experiment house maximums is 0.8 °C, only 0.1 °C less than in the master bedroom. Thus, the awnings result in significantly lower maximum temperatures. It is not clear why many of the maximum temperatures are below the set-point, during both benchmarking and testing. This

Final Report: Summer Performance of Awnings at the CCHT

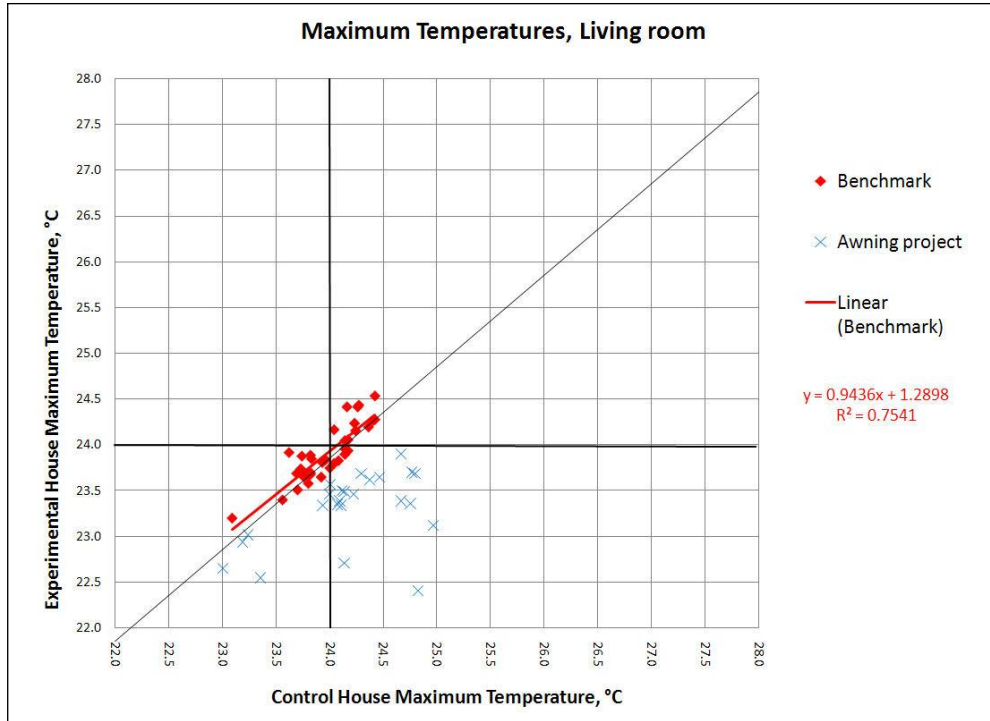

Figure 13. Maximum Daily Temperatures, Living Room.

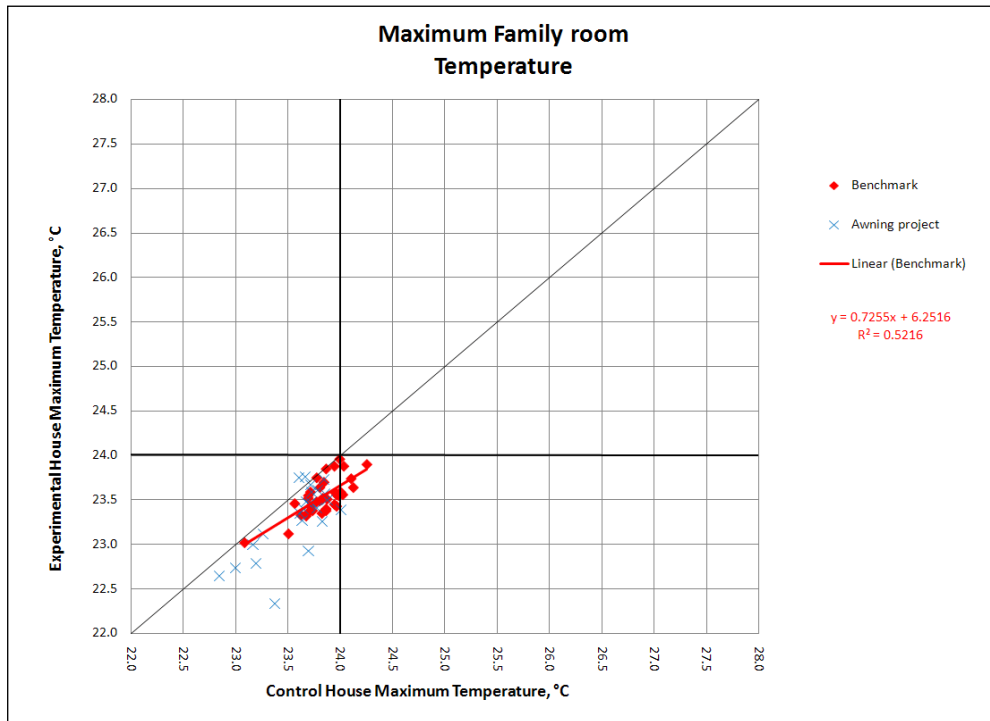

Figure 14. Maximum Daily Temperatures, Family Room.

## *Final Report: Summer Performance of Awnings at the CCHT*

could be due to thermostat accuracy, or due to the warming of air as it flows from supply registers in the living room to the return register below the thermostat.

The higher temperatures on the 2<sup>nd</sup> floor are probably due to the buoyancy of warm air, and the difficulty of blowing denser cold air through the ducts to the upstairs. This is generally believed to be a common occurrence in multi-storey houses with only one thermostat (one zone); basements tend to be cooler than the set-point, while the upstairs tends to be warmer.

Figure 14 is for the family room, which is furthest from the living room and has no awning. During the 36 days of benchmarking, the experiment house family room never went above the set-point, and the control house did so on only five days. During testing, the maximum temperatures in the experiment house were lower on most days, but the difference between the average actual and expected values was only 0.1 °C. The graph for the dining room (no awning, Appendix III) is similar to the one for the living room, as would be expected due to the proximity and lack of a barrier between the two rooms.

In summary, the awnings significantly reduce temperatures in the rooms that have awnings, and in most of the rooms that do not have them. Without awnings, the daily maximum temperatures often exceed the set-point. This indicates that in houses with enough cooling capacity, and enough air circulation to all rooms to maintain the set-point temperature, the awnings could further reduce cooling energy. This ability to effectively cool the house and adequately distribute conditioned air would be the case in houses with zoned heating and cooling, for example. As mentioned, the CCHT is probably typical of most houses, in that the second floor is often not cooled to the set-point. Therefore, the occupants of most (unzoned) houses that install such awnings could expect to benefit from both lower cooling bills and lower temperatures. Houses with zoned heating and cooling could enjoy further reductions in cooling bills.

### **Light Levels**

Light levels (illuminance) were measured in the centre of the living rooms at a height of 0.6 metres. They were measured using photometric sensors, instruments that have approximately the same sensitivity to light of various frequencies as does the human eye. The SI unit of illuminance is the Lux (lx), which is equal to one lumen/m<sup>2</sup>, or 0.0929 footcandles, or 1.46 x 10<sup>-3</sup> light-Watts/m<sup>2</sup>, where a light-Watt is a Watt of radiation to which the human eye is sensitive. Some common light levels are (Engineering ToolBox, expressed in round numbers of footcandles):

<u>Condition</u>	<u>Illumination (lx)</u>
Sunlight	107,527
Full daylight	10,752
Overcast day	1,075
Twilight	10.8
Full moon	0.108
Starlight	0.0011

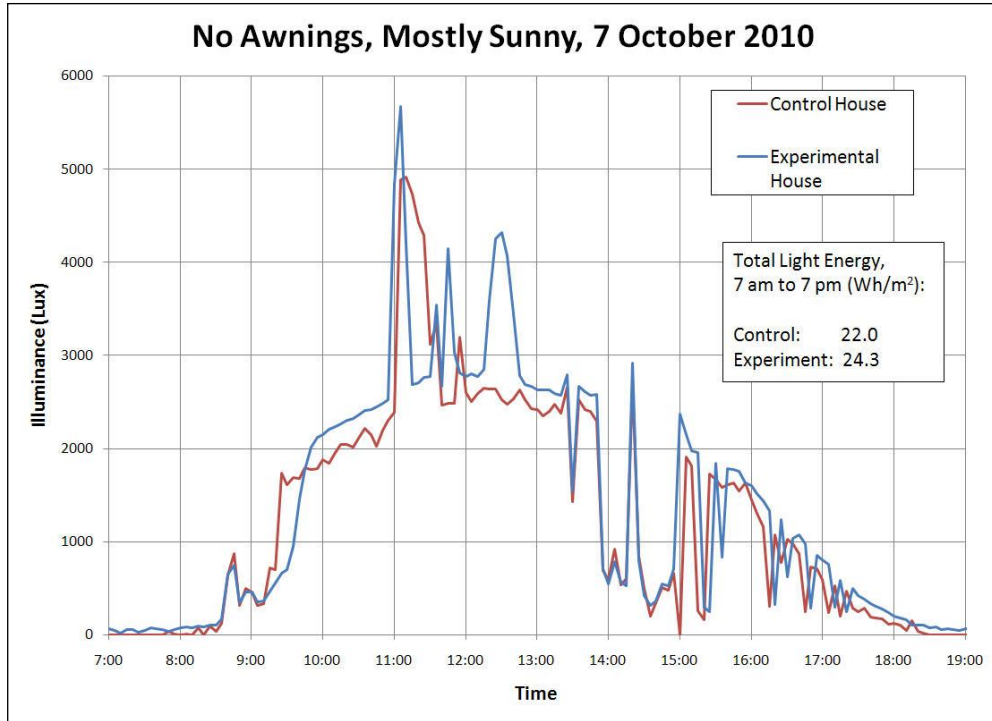

Figure 15. Light Levels on a mostly sunny day with no awnings.

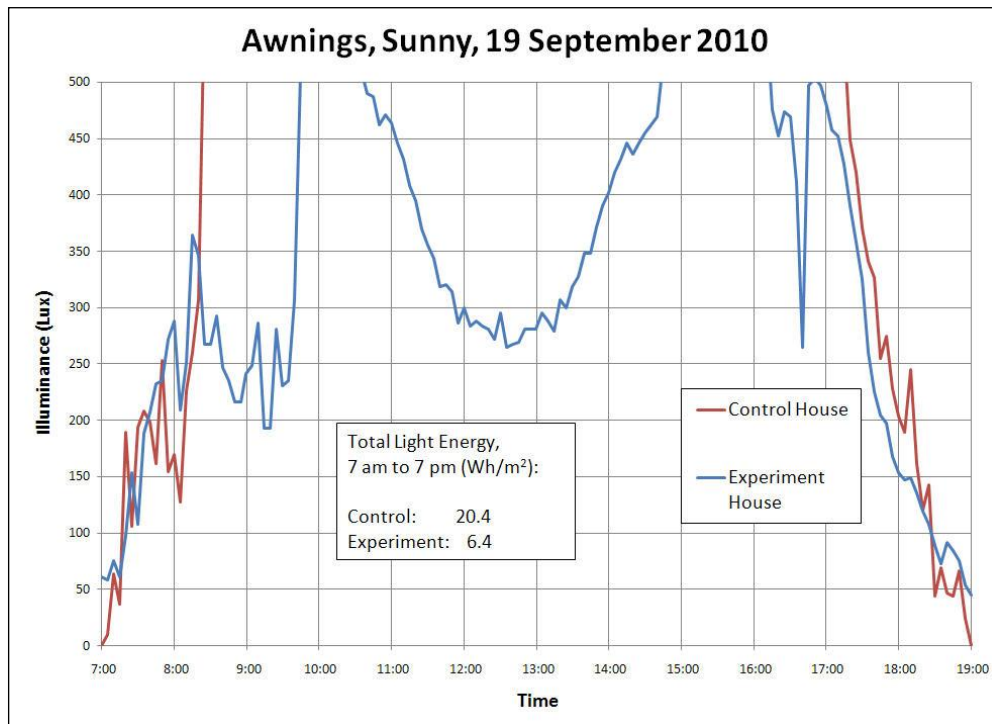

Figure 16. Light Levels on a sunny day with awnings on the experimental house.

## Final Report: Summer Performance of Awnings at the CCHT

Recommended light levels for residential areas vary from 50 to 500 lx, depending of the age of the occupant, and the reflectivity of the surroundings. 75 lx is the central recommendation for general activities, and 300 lx is central for reading magazines (IESNA).

Figure 15 shows the light levels for each five minute period on 7 October 2010, a mostly sunny day with no awnings on either house. The patterns in the two houses are similar although the experiment house receives more light most of the time, and 10% more total light energy for the day. (The data in lx is converted to  $\text{Wh/m}^2$  of light energy as follows:  $\text{lx} \times 1.46 \times 10^{-3} \text{ W/m}^2/\text{lx} \times 5 \text{ min} / 60 \text{ min/h}$ ). The situation is similar on 7 October, a cloudy day during which the control house receives  $2.0 \text{ Wh/m}^2$  and the experiment house receives  $2.9$ .

Figure 16 is a detail of the graph for 19 September 2010, a sunny day during which the awnings were deployed on the experiment house. Here, the control house receives  $20.4 \text{ Wh/m}^2$  and the experiment house receives  $6.4$ . If one looks at the recommended level of 75 lx, both of the houses are above that level for most of the day, and whenever the control house is above it, then the experiment house is also. However, the situation is very different for the level of 300 lx. The control house is above that level continuously from 08:20 until 17:45, during which time the experiment house is often below it. In total, the control house is above 300 lx for three hours more than the experiment house.

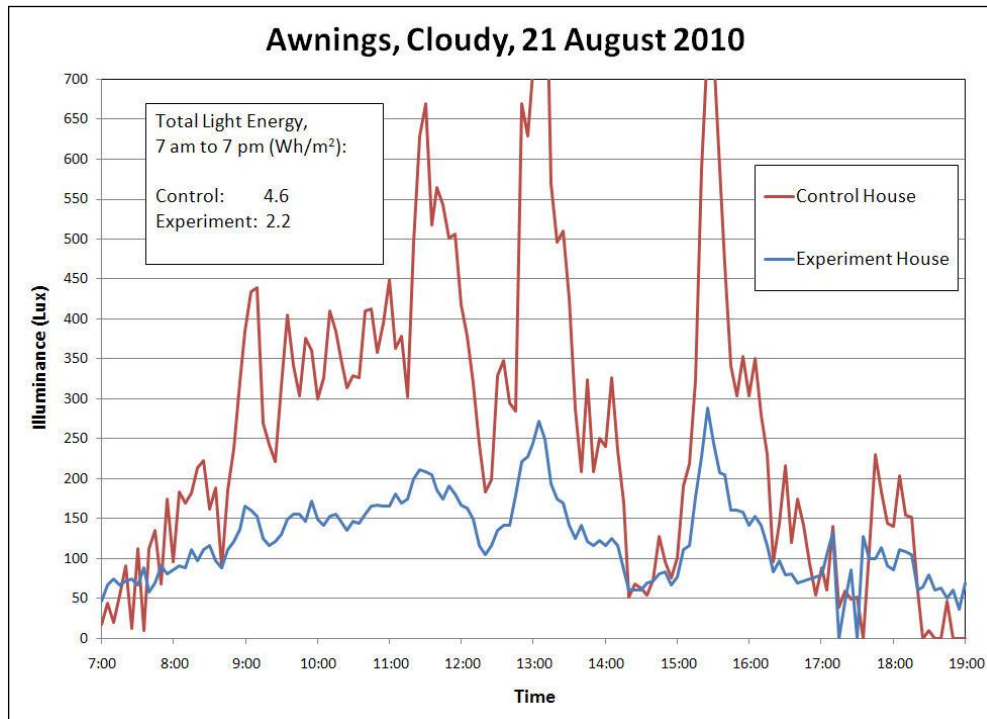

Figure 17. Light Levels on a cloudy day with awnings on the experiment house.

## *Final Report: Summer Performance of Awnings at the CCHT*

Figure 17 shows even greater increases in time below the recommended levels on a cloudy day (21 August). The control house received more than twice the total light energy, was above 75 lx for forty-five minutes more, and above 300 lx for five hours more, as compared to the experiment house. In fact, the experiment house never reached 300 lx.

In summary, awnings do significantly reduce light levels in the rooms to which they are attached, and significantly increase the amount of time that illuminance is below recommended levels. Likely effects on occupants and energy use are discussed below.

## **Comparisons with Other Projects**

This project is the latest of several CCHT investigations on the effects of shading on cooling energy. A 2005 report (Galasiu) showed that closed Venetian blinds on all south facing windows reduced cooling energy by less than 1%. The blinds were the type commonly found in houses, with white aluminum slats, 2.5 cm wide. The results may be counter-intuitive. One might assume that the white blinds would reflect a significant amount of the solar radiation back out of the house. Apparently, the CCHT's double-pane, argon-filled, low-e windows do not allow this, although less energy-efficient windows might. In any case, the results make it seem very unlikely that white Venetian blinds could prevent overheating or reduce cooling loads in very energy-efficient houses. Light levels were not measured, but it seems probable that closed blinds on entire windows would reduce light more than awnings on their top sections. Closed blinds also exclude views.

Another common shading device consists of fixed overhangs above south-facing windows. As mentioned in the introduction, a recent modelling exercise by CanmetENERGY indicated that there are no net benefits from any configuration of fixed overhangs. We are not aware of any empirical study of the effects of fixed overhangs. However, we are confident in the modelling results because they are consistent with the fact that heating and cooling loads lag the angle of the sun above the horizon. That is, there are still significant heating loads just before and after the spring equinox, while the highest heating loads tend to occur well after the summer solstice.

A 2007 project (Manning) investigated custom-made interior shades on the same three south windows used in the awning project plus the west window. The shades consisted of two layers of bubble wrap enclosed in layers of reflective aluminum foil. There were one inch (25.4 mm) gaps at the top and bottom of each window. Measured reductions in cooling energy were 9 or 10%. The shades caused the window surface temperatures to approach the points at which thermal stresses could cause windows to crack. For this reason, they cannot be recommended for the type of windows at the CCHT, nor presumably for more energy-efficient windows. Again, light levels were not measured, but were most likely lower than for awnings, and views were excluded.

Since neither interior shades nor fixed exterior overhangs are effective in reducing cooling loads, that leaves adjustable external shades of one type or another.

## *Final Report: Summer Performance of Awnings at the CCHT*

A report by Laouadi and Galasiu published in 2009 describes the effects of exterior insulating rollshutters on all of the CCHT windows except the two east-facing ones (see Figure 1). The rollshutters were loosely closed, leaving small gaps between the slats to admit some light. Reductions in energy for the A/C compressor and the furnace fan were “~26% ±10%.” In 2010 Laouadi used computer simulations to generalize the results for entire years at several locations. For an R-2000 house in Ottawa (the CCHT houses), annual A/C and fan savings were 45 to 54%, by far the highest of all the shading devices tested. These results are not directly comparable with the awning results because the rollshutters covered the fourth south window and a large west window that were not covered by awnings. Once again, light levels were not measured. The many small gaps in the rollshutters do admit some light, but probably less than the awnings do. The gaps also allow one to see the exterior, but the fractured view may be considered aesthetically unappealing.

In summary, Venetian blinds and exterior overhangs have the advantage of being commonly accepted in houses, but they have no significant effect on cooling energy. Blinds also reduce light levels and exclude exterior views when closed. Interior reflective shades reduce cooling energy by about 10%, but also exclude views and most light, have no practical way of being opened or closed, and put unacceptable stresses on window glass. Exterior rollershutters produce the largest savings in cooling energy, and have other advantages, but have a very unconventional appearance, and exclude most natural lighting and views. Thus, the type of awning tested in this project – with their 18% reduction in cooling energy, may be considered to be the best compromise between energy savings, natural lighting, and aesthetics, although such judgements are of course subjective, and involve uncertainty in the case of light levels since these were not measured for the other devices.

## **Discussion**

As houses in Canada approach net-zero energy, the hardware and technologies involved tend to suffer from diminishing returns. Each additional thickness of insulation costs the same as the previous one, while producing smaller energy savings. Additional gains in improved efficiency of heating, cooling and hot water equipment tend to be small and expensive. Generally, active renewable energy equipment is only cost effective when other measures are well past their points of diminishing returns, and can be severely limited by available space, exposure and building orientation. For these reasons, maximizing free passive solar space heating should be a prime strategy in any building project. If a building is well exposed, and can be built with a southern orientation, then the main limiting factor on passive solar is overheating, which can occur on warmer, sunny days during the heating season, during shoulder seasons, and during the cooling season. This problem cannot be dealt with by fixed overhangs above windows, since they reduce useful solar gains by at least as much as those that increase cooling loads.

A solution to overheating is some form of adjustable shading device. If the shading devices were located inside, they could be easily adjusted by occupants in the way Venetian blinds are. However, experience to date suggests that with energy-efficient windows, internal shading is

## *Final Report: Summer Performance of Awnings at the CCHT*

either ineffective or causes thermal stress on the glass. Therefore, moveable external shading devices are likely to become important parts of (near) net-zero energy houses and should be deployed in any house that seeks to maximise passive solar gains while minimizing potential for over-heating. These could be manually adjusted from the outside, in which case users could deploy them during the cooling season, and retract them for the rest of the year. They could be manually adjusted from the inside, either electrically or physically, as is the case with some rollshutters. Or they could be automatically controlled so that they would only be deployed when needed to prevent excessive solar gains, with manual overrides for privacy or security, or when occupants consider natural light or views more important than excess gains.

This study has shown that retractable canvas awnings that cover approximately the top half of windows can significantly reduce cooling energy. The awnings used were typical commercially available models, and no attempt was made to change their characteristics in order to optimize their performance. They were installed on three of the four south windows, and not on the west window or either of the east windows. Because they cover only about the top half of a window, they allow significant amounts of natural light, and leave much of the view to the outside unobstructed. The awnings reduced cooling energy by 18%, and also kept maximum temperatures much closer to the set-point, in the rooms with awnings and in other rooms, thus providing both energy savings and increased comfort.

Although awnings may reduce light levels less than other shading devices do, it is clear that they do significantly reduce light levels in the rooms to which they are attached, and significantly increase the amount of time that illuminance is below recommended levels. However, the effects this will have on occupants will depend on a number of non-quantifiable and subjective factors. For example, whether occupants are in those rooms during times of low light levels, what activities they are engaged in, and their subjective reactions to particular light levels. It is possible that some will find the reduced lighting unacceptable, and will react by turning on lights, thus negating some of the energy savings. Increased use of lights would increase energy use directly, and also indirectly by increasing cooling loads. However, since savings due to awnings are in the order of three kWh per day, it seems unlikely that occasional increased use of lights would negate a significant amount of the energy savings, especially in energy-efficient houses with energy-efficient lighting. It should also be noted that in very energy-efficient houses, shading devices may be controlled automatically, so that they are only deployed when needed to avoid overheating or increased cooling loads. This is unlikely to occur during periods of low light levels.

## **Conclusions & Recommendations**

Movable external shading devices such as the awnings tested in this project can significantly decrease the energy required for cooling a house while keeping temperatures closer to the desired level. For this reason, they are likely to have an important role in the design of houses that approach net-zero energy, and may be useful in more typical new and existing houses with south-facing windows. In order to maximize the benefits of movable shades to particular house designs

*Final Report: Summer Performance of Awnings at the CCHT*

in particular locations, designers will need accurate simulation models verified by empirical studies such as this one. Such models must deal with the house as a system, and include the ability of floors and walls to store solar gains for later release rather than cause immediate overheating. The use of shading devices may change the choice of windows. For example, as awnings enable the maximisation of solar gains in winter (awning retracted), without causing overheating in summer (awnings deployed), south facing windows designed to maximise solar gains, rather than minimise heat loss may be the preferred design choice. Questions that need to be answered for any given design and location include:

- What are the best lengths and angles for awnings on windows facing different direction?
- What are the effects of side panels?
- What is the best control strategy, and what are the likely effects of occupants overriding the controls for various percentages of the time?

Further work should consist of an iterative process of empirical studies such as this one, and simulation work using models with hourly (or shorter) time steps such as ESP-r and HOT3000. The empirical work can be used to verify and calibrate the models, and the models can be used to produce optimized designs for further testing, and for designing the next generations of (near) net-zero energy houses.

## References

CHBA, *Canadian Home Builder's Association Builders' Manual*, Canadian Home Builders Association, Ottawa, 2008.

Engineering Toolbox. [www.engineeringtoolbox.com/light-level-rooms-d\\_708.html](http://www.engineeringtoolbox.com/light-level-rooms-d_708.html)

Galasiu, A.D., C.F. Reinhart, M.C. Swinton, and M. M. Manning, *Assessment of Energy Performance of Window Shading Systems at the Canadian Centre for Housing Technology*, Research Report No. 196, Institute for Research in Construction, National Research Council Canada, Ottawa, 2005. [www.nrc-cnrc.gc.ca/obj/irc/doc/pubs/rr/rr196/rr196.pdf](http://www.nrc-cnrc.gc.ca/obj/irc/doc/pubs/rr/rr196/rr196.pdf)

IESNA. Illuminating Engineering Society of North America. *Lighting Handbook*, 8th Edition, New York. 1993.

Laouadi , A ., *Guidelines for Effective Residential Solar Shading Devices*, IRC-RR-300, Institute for Research in Construction, National Research Council Canada, Ottawa, 2010.  
[www.ccht-cctr.gc.ca/eng/reports.html](http://www.ccht-cctr.gc.ca/eng/reports.html)

Laouadi , A and Galasiu, A.D., *Window shadings reduce residential cooling energy*, Institute for Research in Construction, National Research Council Canada, Ottawa, 2009.

Manning M.M.; M.C. Swinton and K Ruest, *Assessment of Reflective Interior Shades at the Canadian Centre for Housing Technology*, Canadian Centre for Housing Technology, National Research Council Canada, Ottawa, 2007. [www.nrc-cnrc.gc.ca/obj/irc/doc/pubs/b-6020/b6020.pdf](http://www.nrc-cnrc.gc.ca/obj/irc/doc/pubs/b-6020/b6020.pdf)

## **Appendix I: Window & Awning Geometry**

This appendix shows the detailed configuration of each of the windows with awnings, and a simplified geometry that could be used in modelling the effects of the awnings. Each window consists of three glazing units separated by frames, as can be seen in Figure 2. The outer and central units have different widths, and in two windows, different heights. In all the window drawings, the *width of glazing* is the sum of the widths of the three units, and does not include the frames between them. The *height of glazing* is the area weighted average height of the three glazings. The drawings are not to scale.

Final Report: Summer Performance of Awnings at the CCHT

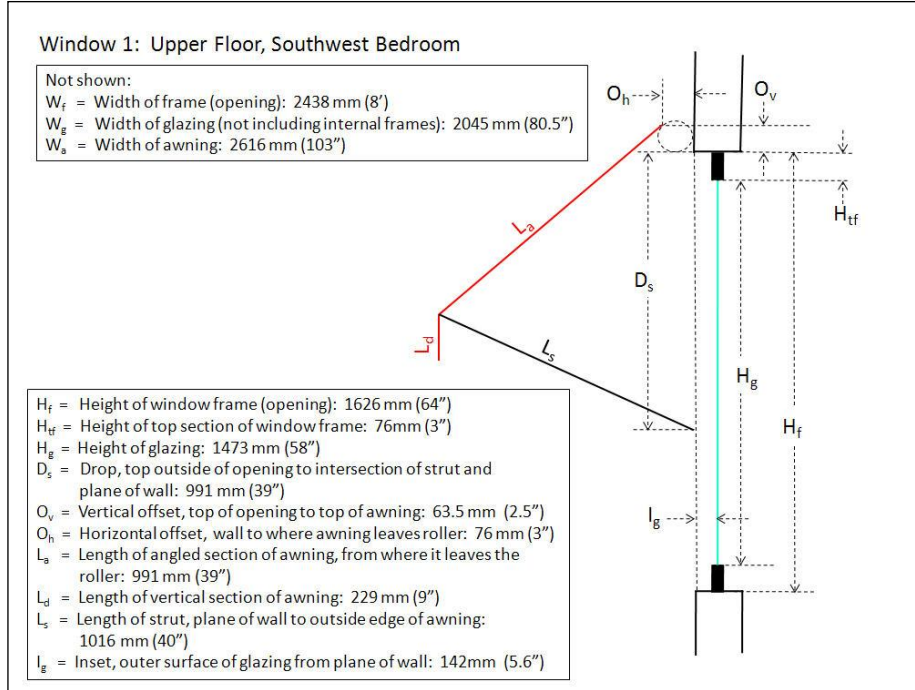

Figure I-1. Configuration of Window 1, Bedroom 2, 2<sup>nd</sup> Floor.

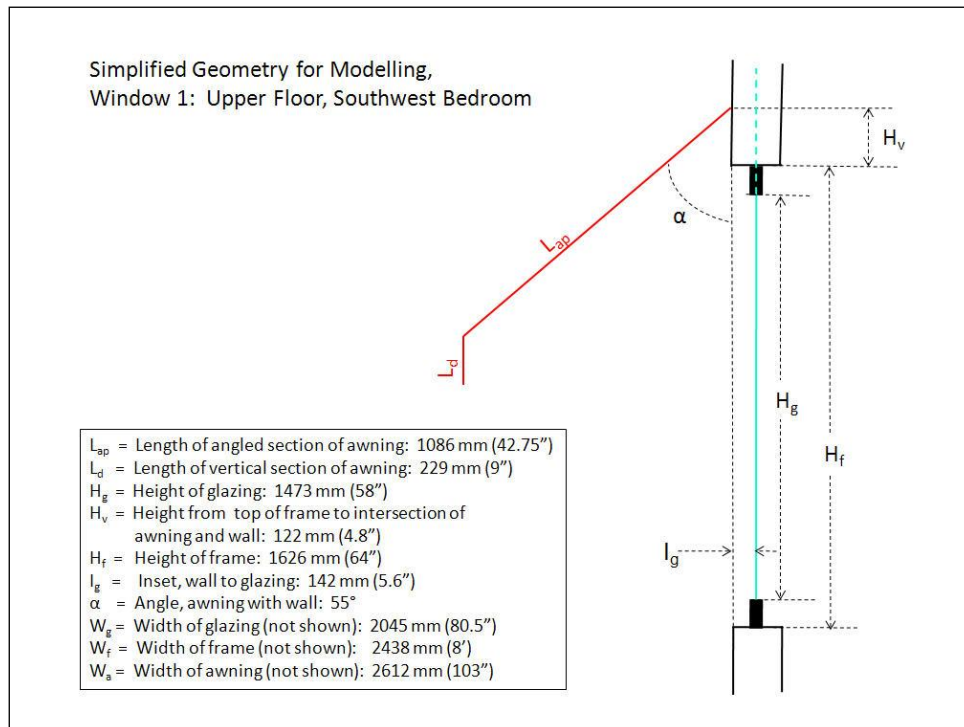

Figure I-2. Simplified Geometry, Window 1.

Final Report: Summer Performance of Awnings at the CCHT

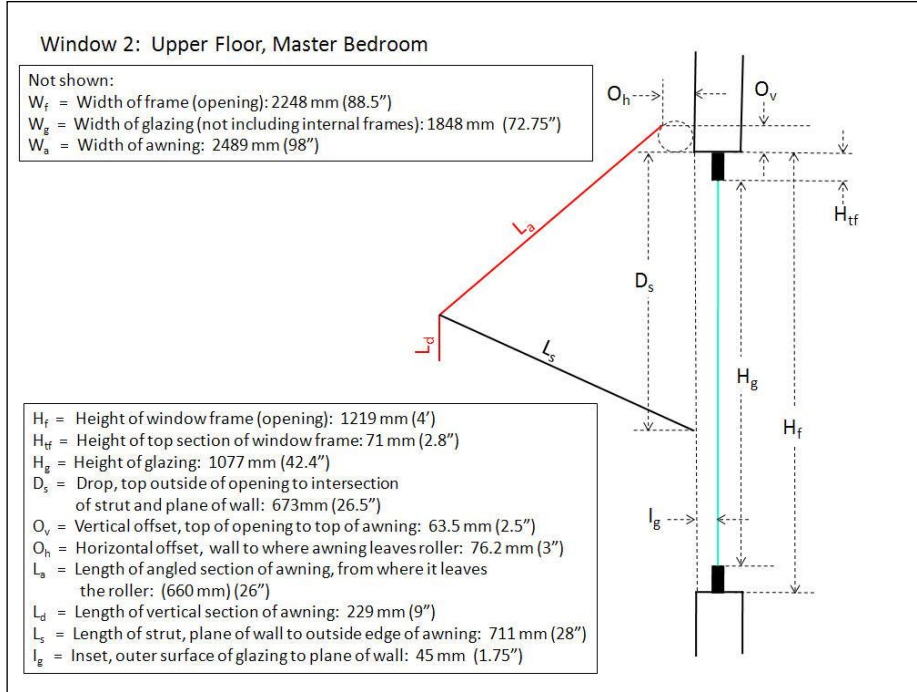

Figure I-3. Configuration of Window 2, Master Bedroom.

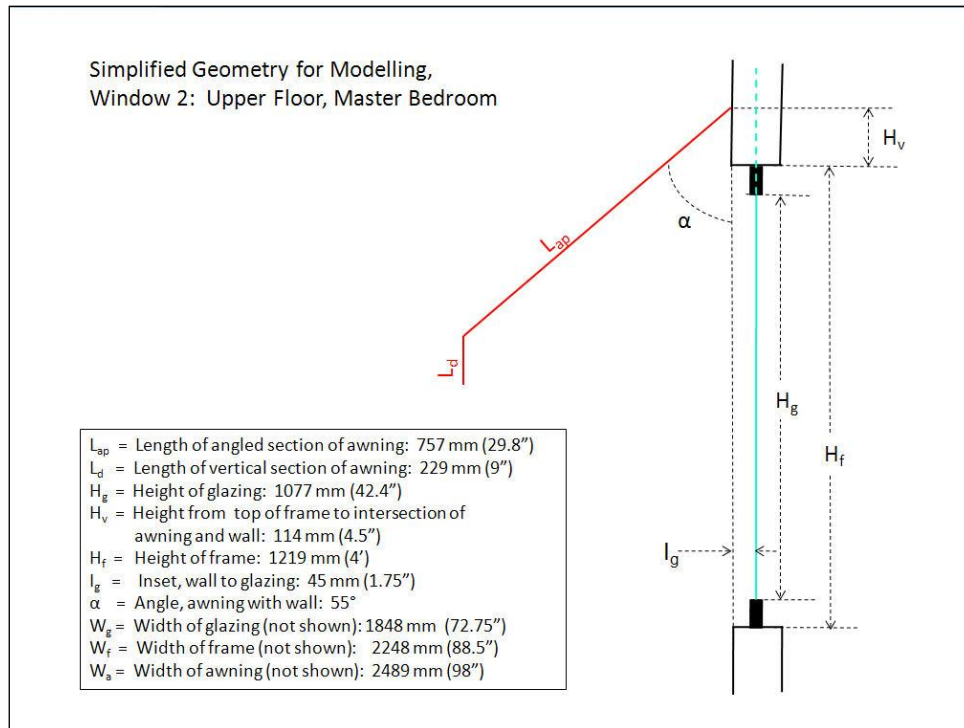

Figure I-4. Simplified Geometry, Window 2.

Final Report: Summer Performance of Awnings at the CCHT

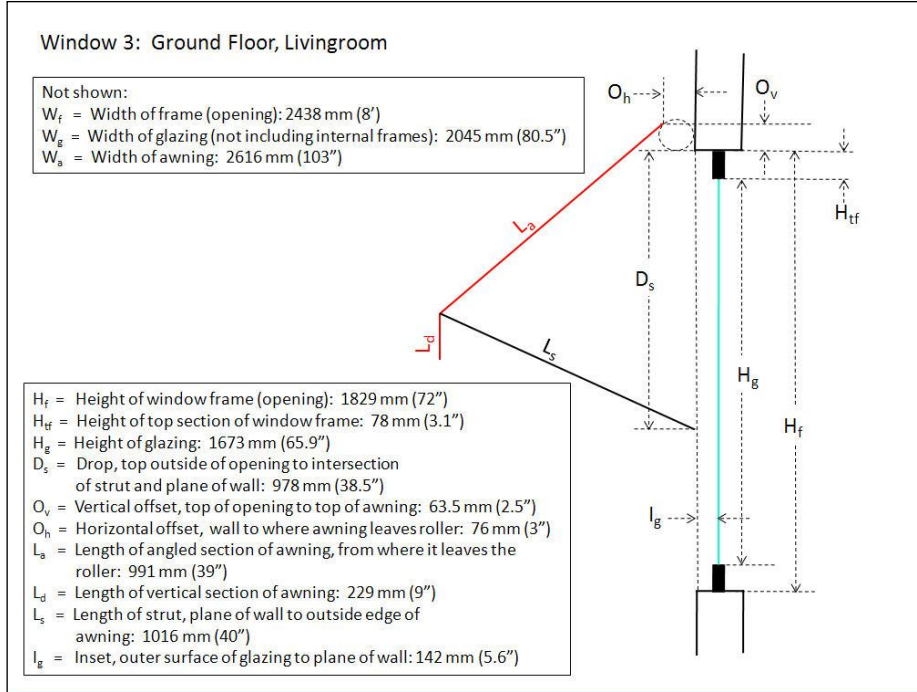

Figure I-5. Configuration of Window 3, Living Room, 1<sup>st</sup> Floor.

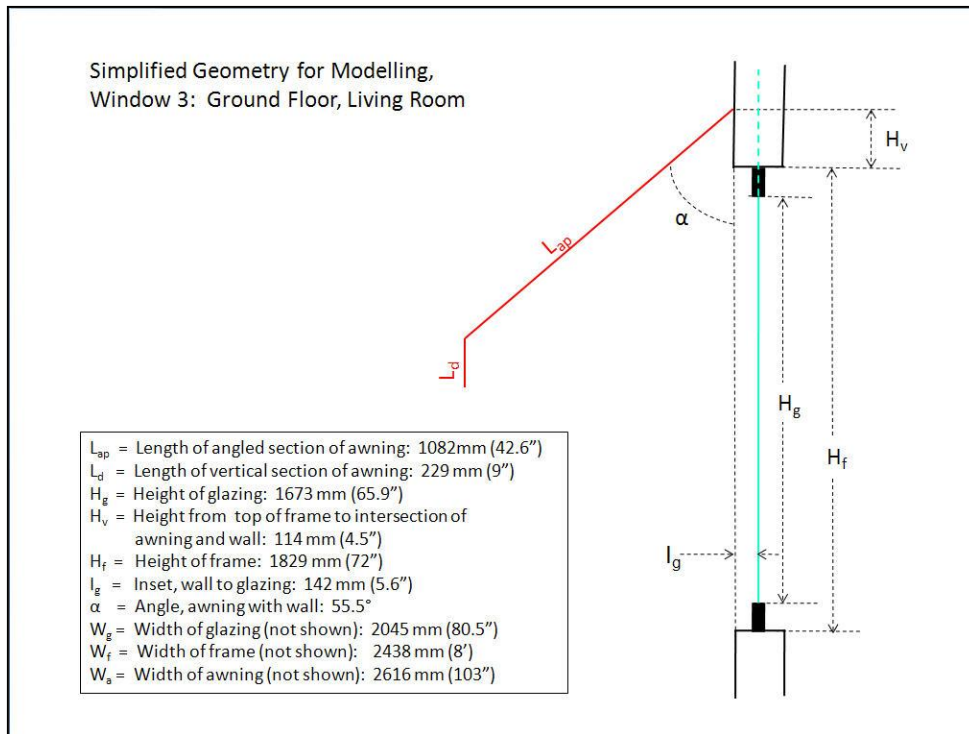

Figure I-6. Simplified Geometry, Window 3.

## Appendix II: Simulated Occupancy Schedule

Note: Water draws shown here are for hot water only, in liters.				
Overnight				
Device	Water Utility	Draw	Time	Duration
Bedroom 2 humans		66.4 W	0:00	6 hrs 45 min
Master bedroom humans		99.6 W	0:00	6 hrs 45 min
Morning				
Device	Water Utility	Draw	Time	Duration
2nd floor lights		410 W	6:45	60.0 min
	1. Master bedroom shower	36 L	6:50	10.2 min
Family room humans		166 W	7:00	60.0 min
Main floor lights		200 W	7:00	60.0 min
Kitchen products		450 W	7:30	10.2 min
Kitchen fan		80 W	7:30	10.2 min
Kitchen stove (intermittent)		1600 W	7:30	20.0 min
	2. Kitchen tap	13 L	7:45	3.0 min
Afternoon				
Device	Water Utility	Draw	Time	Duration
Kitchen fan		80 W	12:00	15.0 min
Kitchen stove (intermittent)		1600 W	12:00	15.0 min
Family room humans		166 W	12:00	30.0 min
Kitchen products		450 W	12:00	10.2 min
Main floor lights		200 W	12:00	15.0 min
	3. Kitchen tap	13 L	12:30	3.0 min
Evening				
Device	Water Utility	Draw	Time	Duration
	4 & 5. Clothes washer (46L)	400 W	17:00	60.0 min
Main floor lights		200 W	17:00	2 hrs 30 min
Kitchen fan		80 W	17:30	3.6 min
Kitchen stove (intermittent)		1600 W	17:30	30.0 min
Family room humans		166 W	17:30	2 hrs 30 min
Kitchen products		450 W	17:30	10.2 min
Dining room products		225 W	18:00	2 hrs
2nd floor lights		410 W	18:00	5 hrs
	6. Kitchen tap	27 L	18:30	6.0 min
	7 & 8. Dishwasher	650 W	19:00	60.0 min
Dryer		2250 W	19:00	25.2 min
Living room humans		166 W	19:00	2 hrs
Bedroom 2 humans		66 W	21:00	3 hrs
	9. Main bathroom bath	41 L	21:05	4.8 min
	10. Master bedroom shower	55 L	22:30	15 min
Master Bedroom Humans		100 W	23:00	60 min

### Appendix III: Additional Graphs of Maximum Temperatures

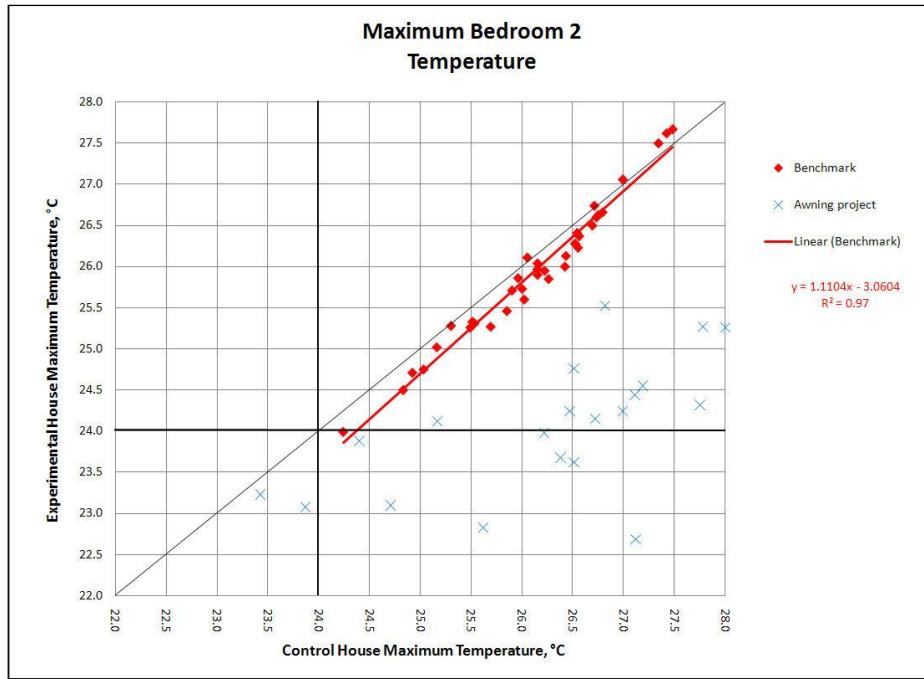

Figure III-1. Maximum Daily Temperatures, Bedroom 2, Second Floor, With Awning.

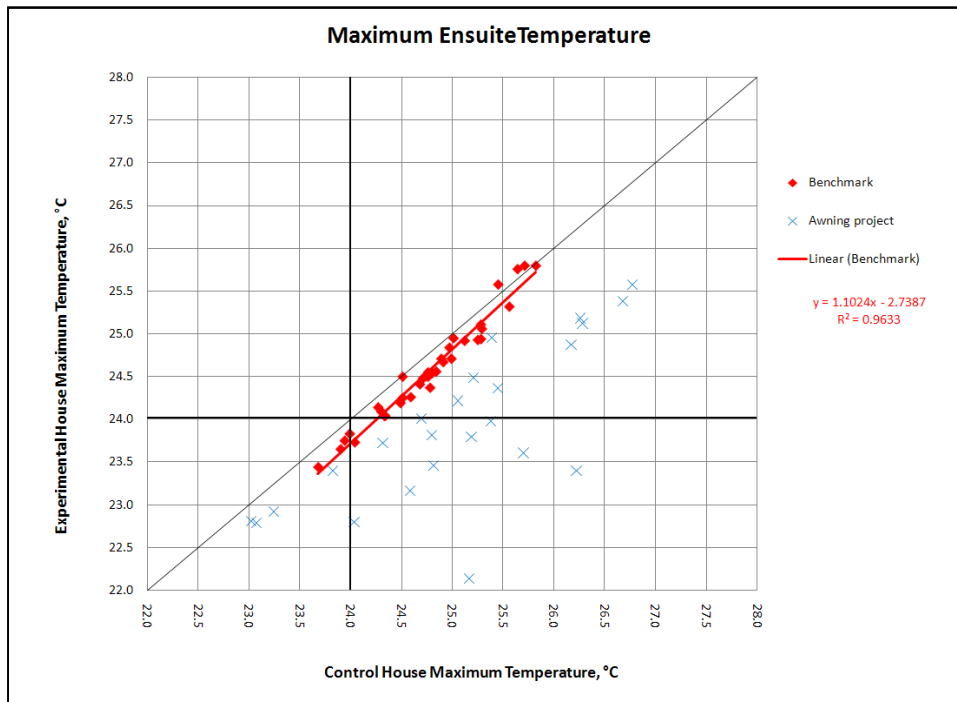

Figure III-2. Maximum Daily Temperatures, Ensuite Bath, Second Floor, No Awning.

Final Report: Summer Performance of Awnings at the CCHT

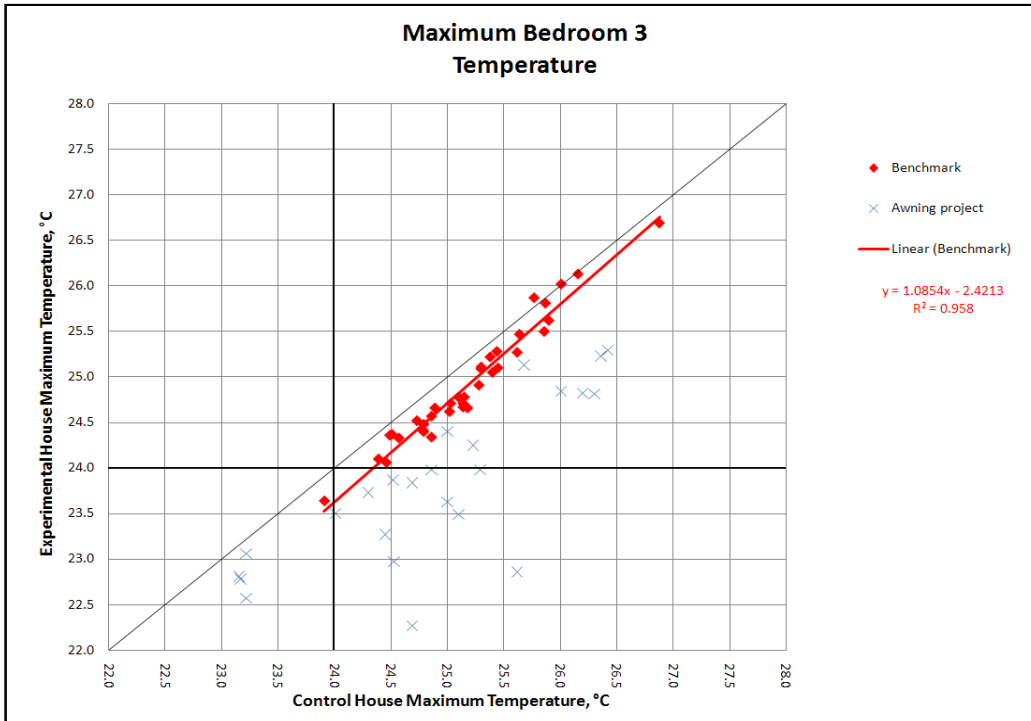

Figure III-3. Maximum Daily Temperatures, Bedroom 3, Second Floor, No Awning.

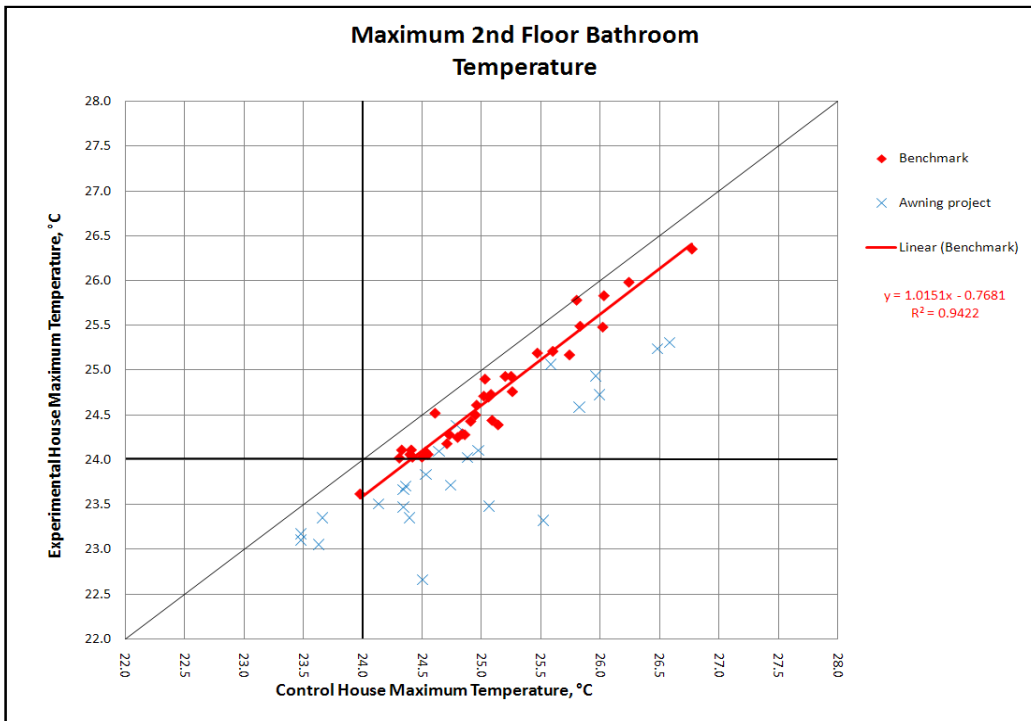

Figure III-4. Maximum Daily Temperatures, Second Floor Bathroom, No Awning.

Final Report: Summer Performance of Awnings at the CCHT

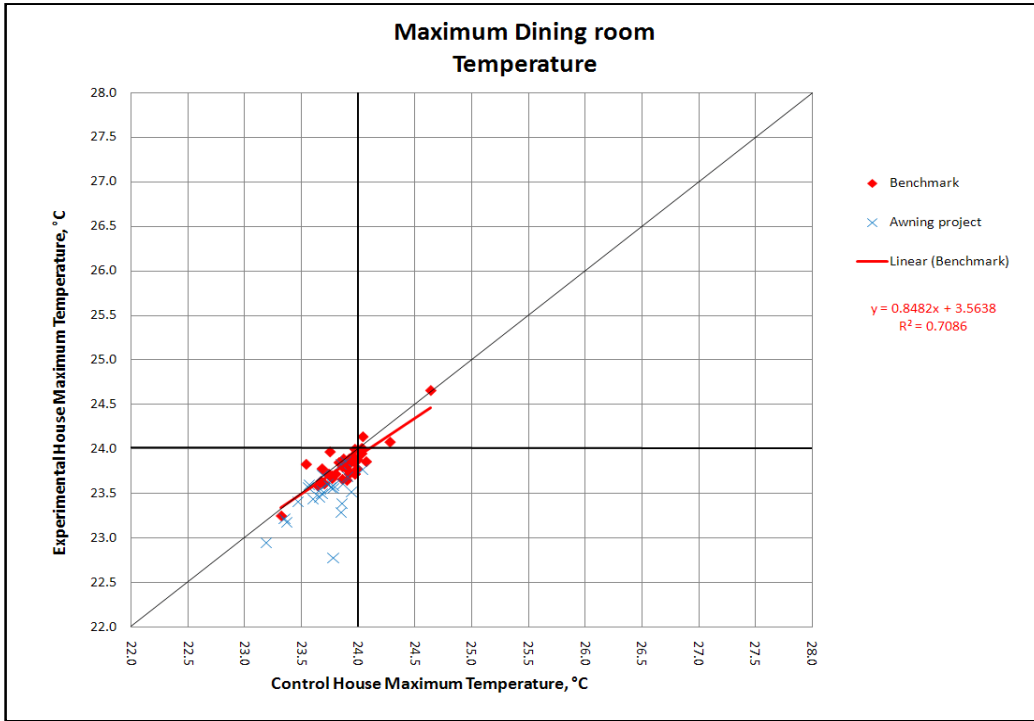

Figure III-5. Maximum Daily Temperatures, First Floor, Living Room, With Awning.

## Appendix IV: Temperature Frequency & Probability Graphs

Comparing the benchmark and testing graphs, the curves for the experiment house are generally shifted to the left, showing cooler temperatures due to the awnings.

The graphs on this page are for the master bedroom, a second floor room with an awning.

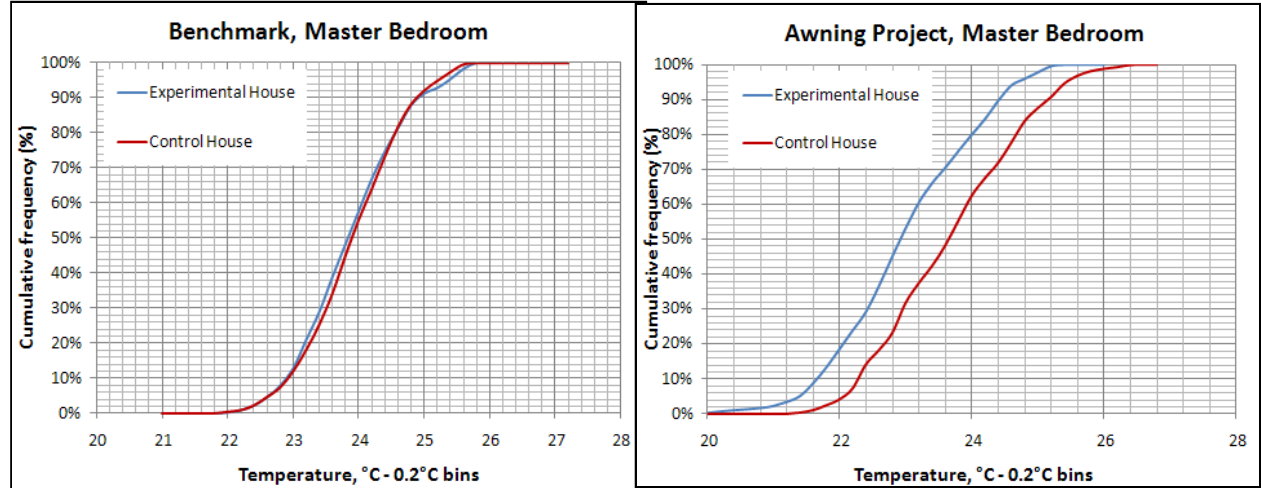

Figure IV-1. Temperature Frequency Distribution, Benchmark & Testing, Master Bedroom.

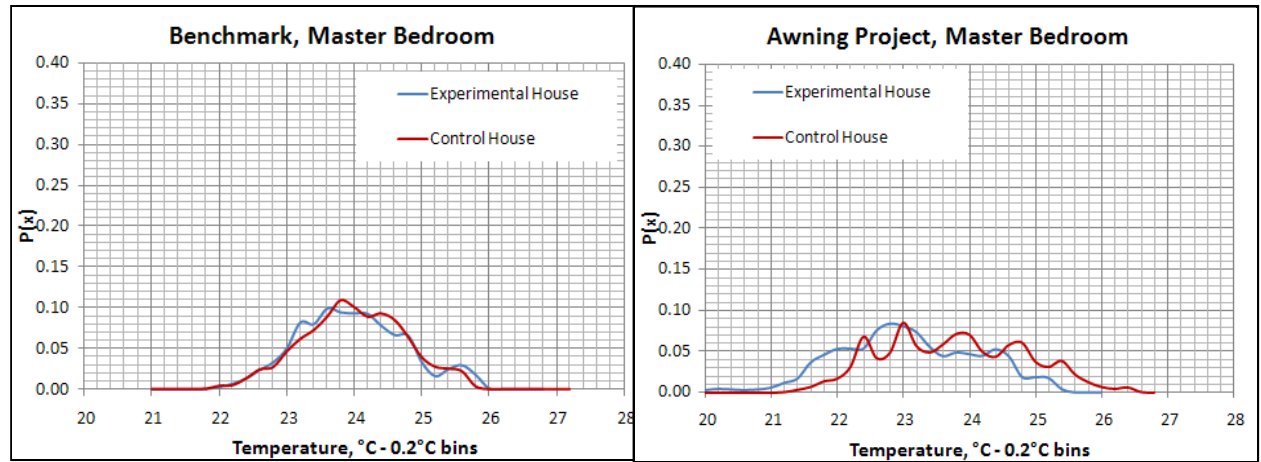

Figure IV-2. Temperature Probability Distribution, Benchmark & Testing, Master Bedroom.

Final Report: Summer Performance of Awnings at the CCHT

The graphs on this page are for Bedroom 4, a second floor room with no awning.

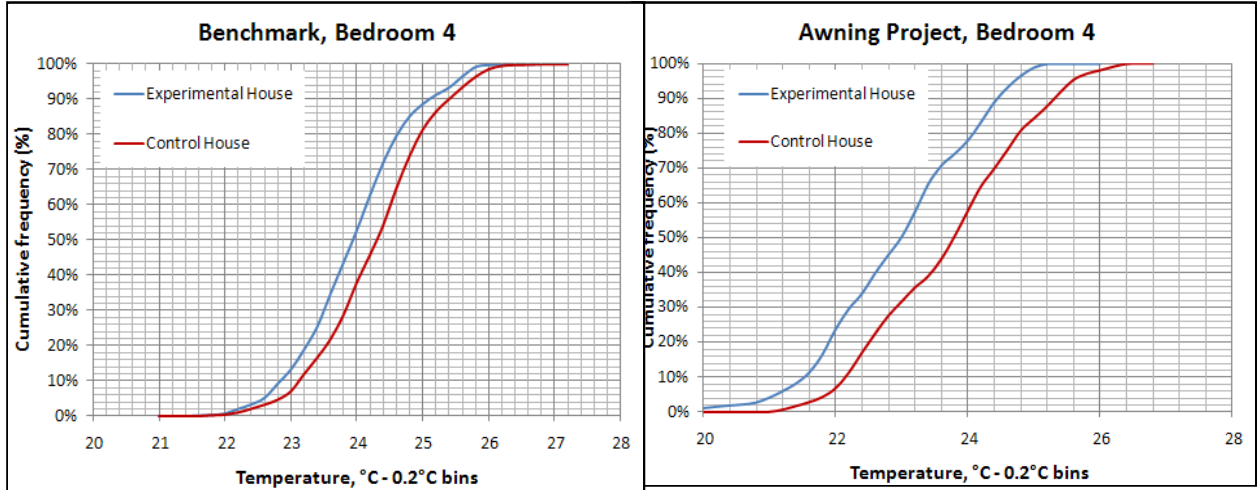

Figure IV-3. Temperature Frequency Distribution, Benchmark & Testing, Bedroom 4.

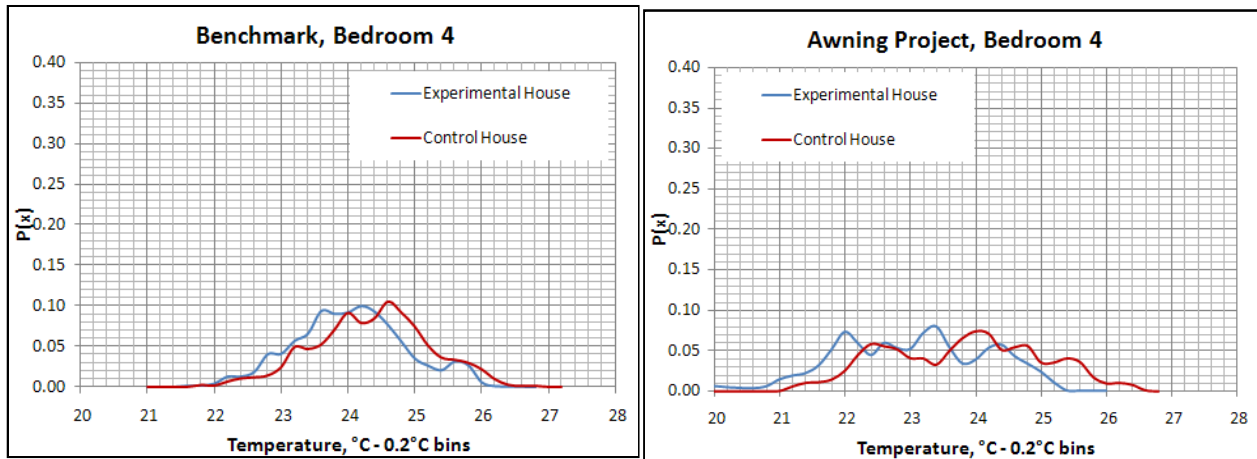

Figure IV-4. Temperature Probability Distribution, Benchmark & Testing, Bedroom 4.

*Final Report: Summer Performance of Awnings at the CCHT*

The graphs on this page are for the living room, a first floor room with an awning.

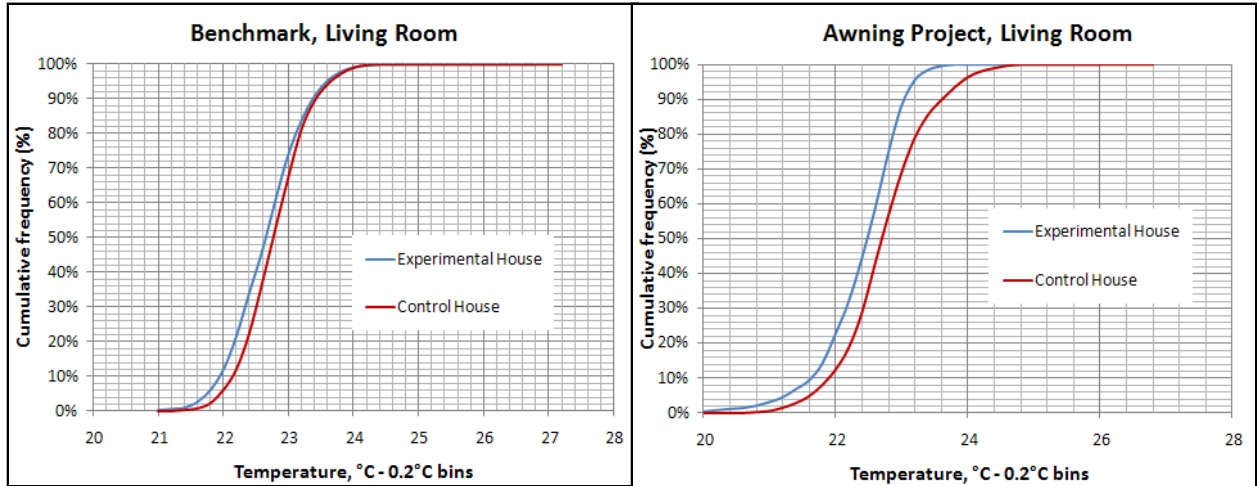

Figure IV-5. Temperature Frequency Distribution, Benchmark & Testing, Living Room.

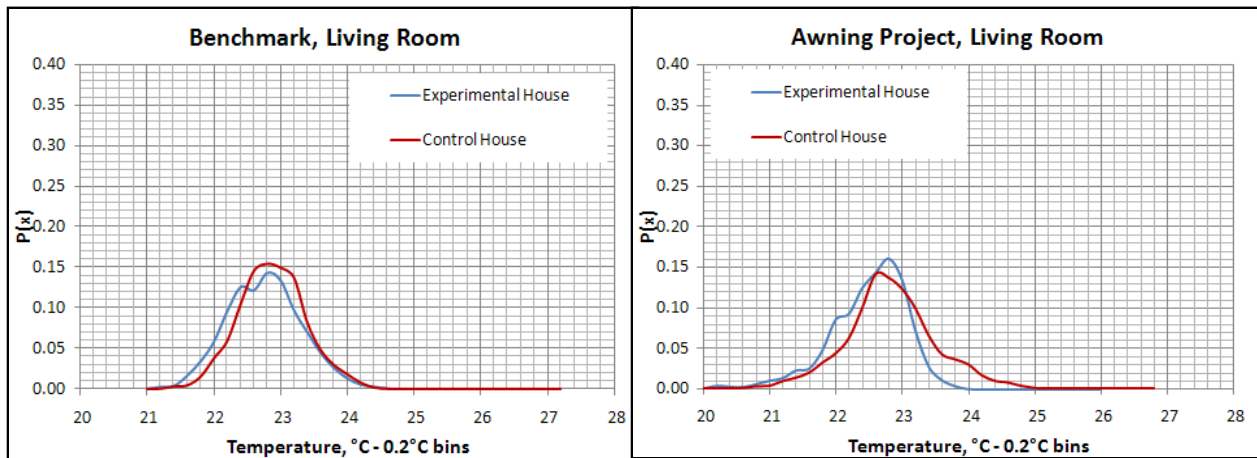

Figure IV-6. Temperature Probability Distribution, Benchmark & Testing, Living Room.