

NRC Publications Archive Archives des publications du CNRC

Manoeuvring in Ice - Test/Trial Database Quinton, B.; Lau, M.

For the publisher's version, please access the DOI link below./ Pour consulter la version de l'éditeur, utilisez le lien DOI ci-dessous.

Publisher's version / Version de l'éditeur:

<https://doi.org/10.4224/8895550>

Student Report; no. SR-2005-13, 2005

NRC Publications Archive Record / Notice des Archives des publications du CNRC :

<https://nrc-publications.canada.ca/eng/view/object/?id=858664f4-0ce1-4d58-88a7-4490b4ab39e5>

<https://publications-cnrc.canada.ca/fra/voir/objet/?id=858664f4-0ce1-4d58-88a7-4490b4ab39e5>

Access and use of this website and the material on it are subject to the Terms and Conditions set forth at

<https://nrc-publications.canada.ca/eng/copyright>

READ THESE TERMS AND CONDITIONS CAREFULLY BEFORE USING THIS WEBSITE.

L'accès à ce site Web et l'utilisation de son contenu sont assujettis aux conditions présentées dans le site

<https://publications-cnrc.canada.ca/fra/droits>

LISEZ CES CONDITIONS ATTENTIVEMENT AVANT D'UTILISER CE SITE WEB.

Questions? Contact the NRC Publications Archive team at

PublicationsArchive-ArchivesPublications@nrc-cnrc.gc.ca. If you wish to email the authors directly, please see the first page of the publication for their contact information.

Vous avez des questions? Nous pouvons vous aider. Pour communiquer directement avec un auteur, consultez la première page de la revue dans laquelle son article a été publié afin de trouver ses coordonnées. Si vous n'arrivez pas à les repérer, communiquez avec nous à PublicationsArchive-ArchivesPublications@nrc-cnrc.gc.ca.

DOCUMENTATION PAGE

REPORT NUMBER	NRC REPORT NUMBER	DATE	
SR-2005-13		January 12, 2006	
REPORT SECURITY CLASSIFICATION		DISTRIBUTION	
Unclassified		Unlimited	
TITLE			
MANOEUVRING IN ICE: A TEST/TRIAL DATABASE			
AUTHOR(S)			
Bruce W. Quinton and Michael Lau			
CORPORATE AUTHOR(S)/PERFORMING AGENCY(S)			
Institute for Ocean Technology, National Research Council, St. John's, NL			
PUBLICATION			
SPONSORING AGENCY(S)			
Institute for Ocean Technology, National Research Council, St. John's, NL			
IOT PROJECT NUMBER		NRC FILE NUMBER	
42_2019_26			
KEY WORDS		PAGES	FIGS.
Maneuvering, Manoeuvring in Ice, Steady Turning Radius, Turning Circle, R/L, Database		62	25
			TABLES
			0
SUMMARY			
<p>To assist in the development of a ship manoeuvring in ice numerical model to be used in marine simulators, a comprehensive database of all existing full- and model-scale ship manoeuvring in ice tests was created.</p> <p>Over 120 reports were reviewed, and the state-of-the-art of icebreaking technologies along with all "ship manoeuvring in ice" test data available in the literature were identified. These data were supplemented with that extracted from the test database of the Institute for Ocean Technology (IOT). Post-1995 test data were taken directly from published reports and pre-1995 test data were extracted from the "Ship in Ice Performance Database Version 1.0" by Transportation Development Centre. All data were consolidated into a Microsoft Excel spreadsheet ready for future analysis.</p> <p>This report presents the result of the literature review and describes the test database. A preliminary analysis of data given in the database is also given.</p>			
ADDRESS			
National Research Council Institute for Ocean Technology Arctic Avenue, P. O. Box 12093 St. John's, NL A1B 3T5 Tel.: (709) 772-5185, Fax: (709) 772-2462			



National Research Council
Canada

Conseil national de recherches
Canada

Institute for Ocean
Technology

Institut des technologies
océaniques

MANOEUVRING IN ICE: A TEST/TRIAL DATABASE

SR-2005-13

Bruce W. Quinton
Michael Lau

January 2006

ACKNOWLEDGEMENTS

The Atlantic Innovation Fund (AIF), which is administrated by ACOA through the Centre for Marine Simulation (CMS) of Memorial University of Newfoundland (MUN), provided the funding for the creation of this database.

A very great thank-you to the staff of the Canada Institute for Scientific and Technical Information (CISTI) – especially Trish LeBlanc and Derek G. Smith – for providing the reports needed to produce this database.

The first author also likes to thank Dr. Michael Lau for providing guidance, support, and mentorship during his stay at NRC-IOT.

ABSTRACT

To assist in the development of a ship manoeuvring in ice numerical model to be used in marine simulators, a comprehensive database of all existing full- and model-scale ship manoeuvring in ice tests was created.

Over 120 reports were reviewed, and the state-of-the-art of icebreaking technologies along with all “ship manoeuvring in ice” test data available in the literature were identified. These data were supplemented with that extracted from the test database of the Institute for Ocean Technology (IOT). Post-1995 test data were taken directly from published reports and pre-1995 test data were extracted from the “Ship in Ice Performance Database Version 1.0” by Transportation Development Centre. All data were consolidated into a Microsoft Excel spreadsheet ready for future analysis.

This report presents the result of the literature review and describes the test database. A preliminary analysis of data given in the database is also given.

TABLE OF CONTENTS

ACKNOWLEDGEMENTS	I
ABSTRACT	II
LIST OF FIGURES.....	V
1.0 INTRODUCTION.....	1
2.0 LITERATURE REVIEW	2
2.1 Manoeuvring in Ice.....	2
2.2 Icebreaking	4
2.3 Icebreaker Design.....	5
2.3.1 Bow designs	5
2.3.1.1 Wedge-shaped bow (conventional)	5
2.3.1.2 Spoon bow.....	5
2.3.1.3 Concave bow	6
2.3.1.4 Thyssen-Wass bow	6
2.3.2 Bow design considerations	7
2.3.3 Mid-body	8
2.3.4 Aft-body	8
2.3.5 Hull appendages.....	9
2.3.5.1 Ice knife	9
2.3.5.2 Friction reducing systems	9
2.3.5.3 Podded icebreakers.....	10
2.3.5.4 Traditional propulsion/rudder arrangements.....	10
2.4 Manoeuvres in Ice.....	12
2.4.1 Full-scale ice manoeuvring	12
2.4.1.1 Turning circle	12
2.4.1.2 Kempf manoeuvre	13
2.4.1.3 Other common manoeuvres	14
2.4.1.4 Auxiliary manoeuvres	17
2.4.2 Model-scale ice manoeuvring	17
2.4.2.1 Free manoeuvre tests.....	17
2.4.2.2 Captive manoeuvre tests	18
3.0 THE DATABASE	25
3.1 Types of Data Reported.....	25
3.1.1 Full-scale manoeuvring trials data types.....	25
3.1.2 “Free running” model tests.....	26
3.1.3 “Captive” model tests.....	26
3.1.4 Common data types.....	28
3.2 Quality of data.....	28
3.2.1 Possible full-/model-scale test procedural errors	29
3.2.2 Errors or missing reported data	29
3.2.3 Human error.....	29
4.0 ESTABLISHED FUNCTIONAL RELATIONSHIPS	30
5.0 DATABASE ANALYSIS.....	32
5.1 Performance Analysis of Individual Icebreaker	32
5.2 Performance Analysis Among Different Icebreakers.....	36

5.3	Analysis of Influencing Factors on R/L.....	39
6.0	SUMMARY AND RECOMMENDATIONS	43
7.0	REFERENCES	44
8.0	BIBLIOGRAPHY.....	51

LIST OF FIGURES

Figure 1:	Pivot Point Illustration (taken from Menon et al, 1991).....	3
Figure 2:	Generalized Icebreaking Process (taken from Yamaguchi et al, 1997).....	4
Figure 3:	Conventional Wedge Bow (<i>Taymir</i> , taken from Yamaguchi et al, 1997).	5
Figure 4:	Spoon Bow (<i>Robert LeMeur</i> or <i>Canmar Kigoriak</i> , taken from Peirce et al, 1987 (left) and Yamaguchi et al, 1997 (right)).....	6
Figure 5:	Concave Bow (<i>Polarstern</i> , taken from Yamaguchi et al, 1997).....	6
Figure 6:	Thyssen-Wass Bow (<i>Max Waldeck</i> or <i>Mud'Yug</i> , taken from Peirce et al, 1987).....	7
Figure 7:	Square Bow (conventional, taken from Peirce et al, 1987).....	7
Figure 8:	Traditional Screw/Rudder Arrangements (Peirce and Peirce, 1987).....	11
Figure 9:	Turning Circle Schematic (Kendrick et al., 1984).	13
Figure 10:	Kempf Manoeuvre Schematic (reproduced from Kendrick et al., 1984)...	14
Figure 11:	Captain's Turn (Tue-Fee, 1985).....	15
Figure 12:	Modified Captain's Turn (Tue-Fee, 1985).....	16
Figure 13:	Standard PMM Tests (modified from Marineering Limited, 1997).....	21
Figure 14:	USCGC <i>Polar Star</i>	32
Figure 15:	R/L vs. Ice Thickness (h_i).....	33
Figure 16:	R/L vs. Rudder Angle (δ).....	34
Figure 17:	R/L vs. Ship Speed (V).	35
Figure 18:	R/L vs. Ice Thickness (h_i) for Two Narrow Bands.	36
Figure 19:	R/L vs. Scaled Model Speed (V) for Similar Test Conditions.....	37
Figure 20:	R/L vs. L/B for Similar Test Conditions.	38
Figure 21:	R/L vs. C_B for Similar Test Conditions.....	38
Figure 22:	R/L vs. L/D for Similar Test Conditions.	39
Figure 23:	R/L vs. h_i Trends.....	40
Figure 24:	R/L vs. Ship Speed Trends.....	41
Figure 25:	R/L vs. Heel Angle Trends.....	42

Nomenclature

L	Ship's waterline length (L_{WL}) [m]	$Y_{\dot{v}}$	Derivative of sway force due to sway acceleration [kg]
B	Ship's beam [m]	$N_{\dot{v}}$	Derivative of yaw moment due to sway acceleration [kg-m]
m	Mass [kg]	Y_{δ}	Derivative of sway force due to rudder angle [kg-m/s ²]
C_B	Block coefficient	N_{δ}	Derivative of yaw moment due to rudder angle [kg-m ² /s ²]
I_z	Yaw moment of inertia [kg-m ²]	Y_r	Derivative of sway force due to yaw rate [kg-m/s]
R_b	Icebreaking resistance [N]	N_r	Derivative of yaw moment due to yaw rate [kg-m ² /s]
σ_f	Ice flexure strength [Pa]	$Y_{\dot{r}}$	Derivative of sway force due to yaw acceleration [kg-m]
h	Ice thickness [m]	$N_{\dot{r}}$	Derivative of yaw moment due to yaw acceleration [kg-m ²]
l_{cr}	Crack length [m]	Y'_v	Non-dimensional derivative of Y due to v
R	Steady turning radius [m]	N'_v	Non-dimensional derivative of N due to v
R/L	Non-dimensional steady turning radius	$Y'_{\dot{v}}$	Non-dimensional derivative of Y due to \dot{v}
V	Forward speed [m/s]	$N'_{\dot{v}}$	Non-dimensional derivative of N due to \dot{v}
v	Lateral speed [m/s]	Y'_r	Non-dimensional derivative of Y due to r
\dot{v}	Lateral acceleration [m/s ²]	N'_r	Non-dimensional derivative of N due to r
R	Turning radius [m]	$Y'_{\dot{r}}$	Non-dimensional derivative of Y due to \dot{r}
r	Yaw rate [rad/s]	$N'_{\dot{r}}$	Non-dimensional derivative of N due to \dot{r}
\dot{r}	Yaw acceleration [rad/s ²]	Y'_{δ}	Non-dimensional derivative of Y due to δ
t	Time [s]	N'_{δ}	Non-dimensional derivative of N due to δ
x_G	Position of centre of gravity [m]		
Y_o	Sway amplitude [m]		
K	Roll moment [N-m]		
N	Yaw moment [N-m]		
X	Surge Force [N]		
Y	Sway Force [N]		
T	Draft [m]		
x	Forward position from global origin [m]		
y	Lateral position from global origin [m]		
τ	Period of oscillation [s]		
ϕ	Yaw angle [degrees]		
β	Drift angle [degrees]		
δ	Rudder angle [degrees]		
ω	Circular Frequency [rad/s]		
λ	Scale factor		
Y_v	Derivative of sway force due to sway velocity [kg/s]		
N_v	Derivative of yaw moment due to sway velocity [kg-m/s]		

1.0 INTRODUCTION

To assist in the development of a ship manoeuvring in ice numerical model to be used in marine simulators, it was decided that a comprehensive database containing all existing full- and model-scale ship manoeuvring in ice tests be created. Such a database would provide insights for better planning of further experiments and to facilitate the validation of numerical models by improved access to the existing experimental data.

In May 1995, a ship performance in ice database called “Ship in Ice Performance Database Version 1.0” (Transportation Development Centre, 1995) was developed by CANATEC Consultants Ltd. for the Transportation Development Centre. This database has not been updated since its release and advances in computer technology (i.e. moving away from 8 and 16-bit programs) necessitate the creation of a new database. The manoeuvring data contained in the old database has been incorporated into the new database.

Full- and model-scale data from “ship manoeuvring in ice” tests performed in “level ice” conditions are the primary concern for this database; however, some “pack ice”, “rubble ice”, and “open water” manoeuvring data are also presented.

The database has been created in a basic spreadsheet format (Microsoft Excel) because this format provides easy access and facilitates basic analysis. The information can also be easily converted to another format for future database development if required.

The full-scale trials presented consist of turning circles and Kempf (sinusoidal or zig-zag) tests. Two types of model-scale tests were included: “free running” and “captive” tests. For the “free running” model tests the model was not restricted in any fashion and was free in all six degrees of freedom. The captive tests (or PMM tests) were performed with the model attached to a “Planar Motion Mechanism” (PMM), which forced the model to perform prescribed motions. For PMM tests the model is restricted in yaw, sway, surge, and sometimes, roll; but free to heave and pitch.

This report describes the steps taken toward the completion of the new “Manoeuvring in Ice Database” and provides the culmination of an extensive literature review into the state-of-the-art for icebreaker design and testing. It also includes a bibliography outlining all reports reviewed and relevant to the creation of this database and report.

2.0 LITERATURE REVIEW

This section briefly reviews the state-of-the-art on ice-transiting vessel manoeuvring technologies and characteristics. It summarizes icebreaker manoeuvring, icebreaker design, and icebreaker testing.

2.1 Manoeuvring in Ice

A vessel's ability to manoeuvre in level ice depends on its available steering forces and its transverse/rotational resistance. Sufficient steering force and propulsive power are required to overcome the increased turning moment generated by the ice force along the side of the hull during initiation of a turn, and to reach a steady turning rate.

Steering forces are achieved through lift generated by water flow over the rudder(s), differential propeller shaft thrust, directional thrust capability (such as podded-propellers and adjustable propeller nozzle direction), bow thrusters, and lift generated from vessel heel angle. A vessel's transverse and rotational resistances are directly influenced by its L/B ratio (Peirce and Peirce, 1987), block coefficient (C_B), shape of the icebreaking waterline, slope of the hull (or "icebreaking angle") along the icebreaking waterline, shape of its underwater hull, and its pivot point.

During a turn, the pivot point (illustrated in Figure 1) is the (instantaneous) point along a ship's centreline (for basic planar motions) that has its velocity vector directed purely in the surge direction, i.e. the point of zero attack angle. All points ahead of the pivot point have some component of their velocity in the direction of the turn and all points aft of the pivot point have some component directed away from the turn. In other words, the pivot point is the instantaneous centre of rotation of a vessel about a vertical axis. In practice, the pivot point is located within $0.2L$ of the bow and varies by about 0 to $0.5L$ (Menon et al., 1991). The closer the pivot point is to the vessel's centre of gravity, the greater the ability of the vessel to turn (Peirce and Peirce, 1987). Pivot point location also varies with ice thickness (Menon et al., 1991), further contributing to its dynamic nature.

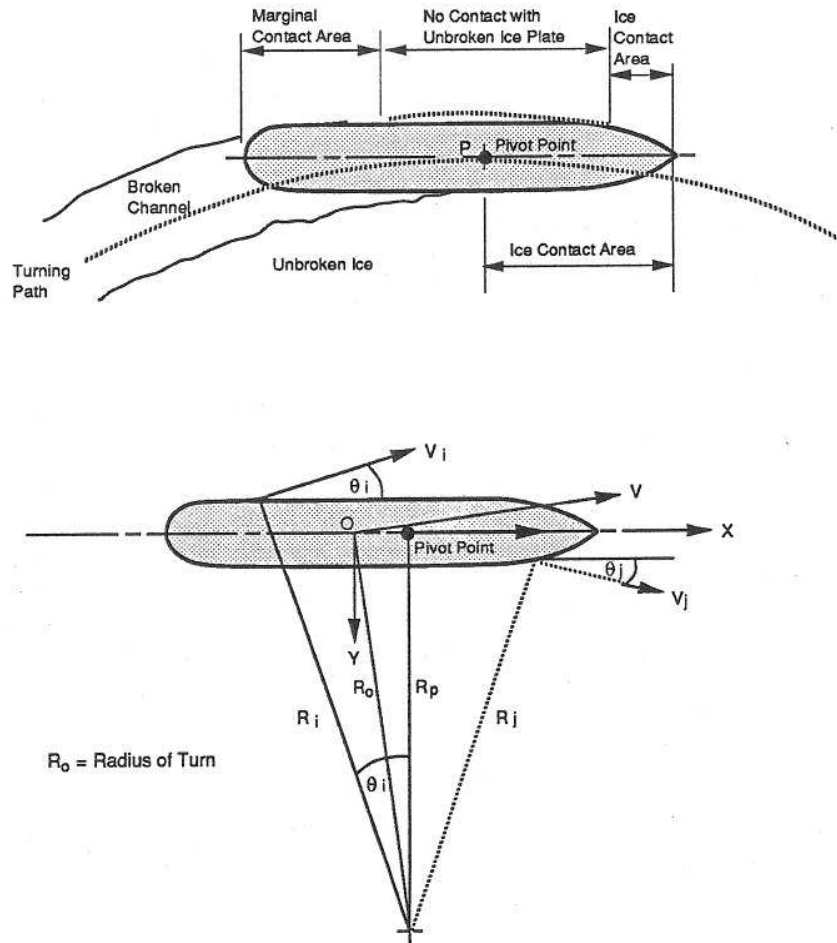

Figure 1: Pivot Point Illustration (taken from Menon et al, 1991).

Events associated with a vessel manoeuvring in level uniform homogenous ice can be categorized by ice thickness. For very thin ice, a vessel's turning radius will normally be very near that of its open water turning radius. This is mainly due to the icebreaking action of the bow wave. As ice thickness increases, the effect of the bow wave diminishes and the ice sheet begins to interact with the vessel's hull. Ice breaking occurs mostly at the bow. The broken channel is wider than the vessel's beam so that the stern can move out and point the bow into the turn. The sides and aft of vessel also break ice. As ice thickness increases, the vessel's ability to clear away broken ice from between its sides and the ice channel edges diminishes. A limiting ice thickness is approached where turning resistance is too great and the vessel is no longer able to turn at all. Quantitative values for ice thicknesses were not provided in the description because thickness alone does not dominate the ship-ice interactions. Ice strength, both in flexural and crushing, and hull-ice friction are also major influential factors. For other conditions, ice distribution (pack or rubble ice, ridges, etc...), ice pressure (e.g. due to wind), snow cover, surface current, and water depth also directly impact a vessel's manoeuvring ability.

2.2 Icebreaking

Icebreaking is extremely complex with many processes taking place simultaneously. Each process may in turn depend on many factors. Ice strength and elastic modulus, ice density, ice thickness, grain orientation, and ice temperature and salinity, are parameters of ice that influence these processes. Speed of ship-ice interaction also plays an important role in the icebreaking process. High-speed (and therefore highly dynamic) and low-speed (almost static) ship-ice interactions under the same conditions will behave very differently. Ship-ice interactions involving ice flooding (part of the parent ice sheet is totally submerged before it breaks) behave differently than situations where the ice does not flood.

Studies such as Ettema et al (1991) have shown that icebreaking processes are chaotic. However, for illustrative purposes, icebreaking can be described as a cyclic process consisting of the following sub-processes (Figure 2) (Yamaguchi et al, 1997):

1. Bow contacts ice sheet and initial ice crushing occurs,
2. Ice sheet begins to deflect downward along bow as vessel advances (ice flooding may occur),
3. Ice pieces are broken off and begin to rotate and orient themselves against the vessel's hull,
4. Ice pieces continue to rotate and slide along the vessel's hull,
5. Bow contacts the ice sheet and the cycle repeats

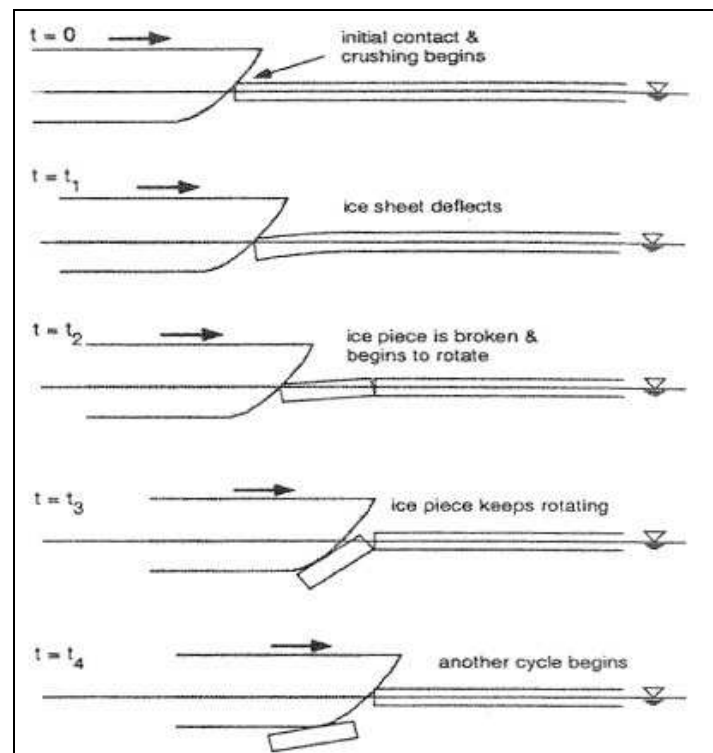

Figure 2: Generalized Icebreaking Process (taken from Yamaguchi et al, 1997).

2.3 Icebreaker Design

Ice transiting vessel design is primarily based on the vessel's intended use. For example, a cargo icebreaker generally does not require good manoeuvrability; its hull is optimized for steady forward motion. Service icebreakers have a greater need for manoeuvrability and therefore a careful balance is found between a good transiting hull shape and a good manoeuvring hull shape for each new design.

Vessels having good manoeuvrability in ice usually have smaller L/B ratios (say 3-5) with larger side-flare angles (say 5° to 15°) (Peirce & Peirce, 1987). While these characteristics are not favourable for ice transiting vessels, certain other hull characteristics are complementary to both, such as under-water hull form.

The best compromise between transiting and manoeuvrability has been shown to consist of moderate L/B ratios and high under-water hull shapes along with large stem angles, stern angles, and side-flare angles (measured from vertical axis). These criteria lead to an elliptical-cone shaped hull.

2.3.1 Bow designs

2.3.1.1 Wedge-shaped bow (conventional)

The conventional Russian icebreaker bow is “V-shaped” with a very high flare angle (Figure 3). The stem angle is about 25° and the forefoot is more than 4 metres below the load waterline, i.e. Russian nuclear icebreaker *Taymir*.

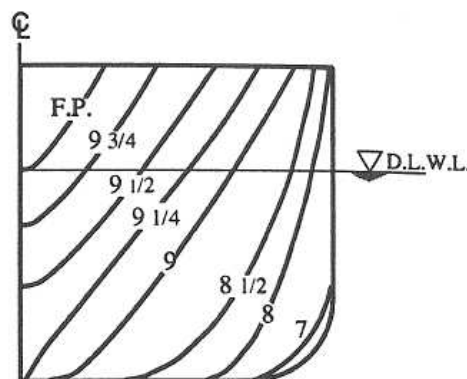

Figure 3: Conventional Wedge Bow (*Taymir*, taken from Yamaguchi et al, 1997).

2.3.1.2 Spoon bow

The spoon bow is generally considered an improvement over the conventional bow (see 2.3.2). Circular waterlines and convex outward frame lines characterize this bow (Figure 4). It has a large flare angle, especially near the stem (which has a typical angle of about 19°). The forefoot is typically more than 2 metres below the load waterline (Yamaguchi et al., 1997). The *Canmar Kigoriak* and the *Robert LeMeur* are both outfitted with spoon bows.

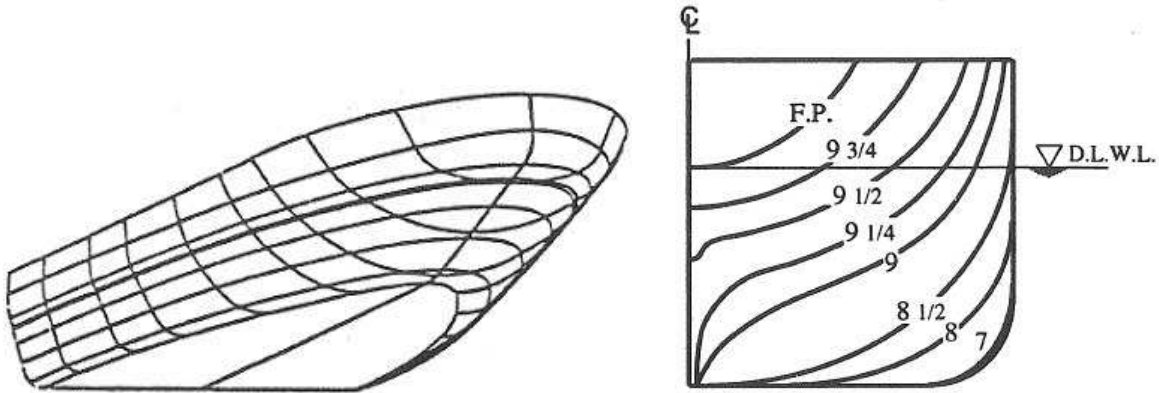

Figure 4: Spoon Bow (*Robert LeMeur* or *Canmar Kigoriak*, taken from Peirce et al, 1987 (left) and Yamaguchi et al, 1997 (right)).

2.3.1.3 Concave bow

This bow is based on the bow of the German icebreaker *Polarstern*. It has concave frame lines and a large constant flare angle that stays constant from the stem to the end of the shoulder (Figure 5).

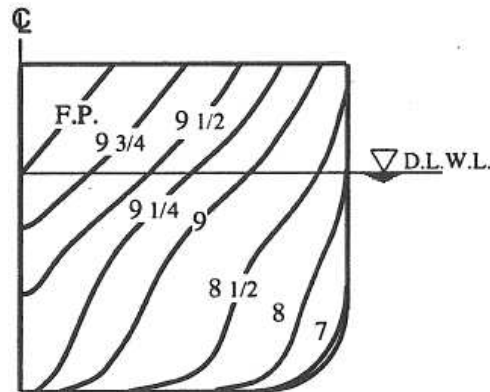

Figure 5: Concave Bow (*Polarstern*, taken from Yamaguchi et al, 1997).

2.3.1.4 Thyssen-Wass bow

Another development in bow shape is the Thyssen-Waas bow (Figure 6). Thyssen Nordseewerke (TNSW) developed this bow based on the original design by Dr. Heinrich Wass (Figure 7). The bow is essentially a square bow with a flat sloping bottom and with raised “runners” along the sides. It has vertical sides and reamers attached at the shoulders. As the flat bottom progresses below the water line it is faired into a v-shaped hull. The Thyssen-Waas bow has been successfully tested at the HSVA (Freitas, 1981 and 1987, and Hellmann, 1983), and outfitted on the German *Max Waldeck* and the Russian *Mud'Yug*. Reports of model tests and full-scale ice manoeuvring trials have been good except for tests done at the Institute for Ocean Technology's (IOT, formerly Institute for Marine Dynamics) ice tank where the performance of the R-class and Thyssen-Waas bows were compared. The Thyssen-Waas bow was found to have no

significant improvements over the R-class bow and worse performance in the areas of open water resistance and ice-clearing. Specifically, the reamers were not deep enough to clear the broken ice pieces under the intact ice sheet on both sides of the channel. The broken ice was carried along the hull and into the propellers and eventually into the broken channel (Spencer, 1997).

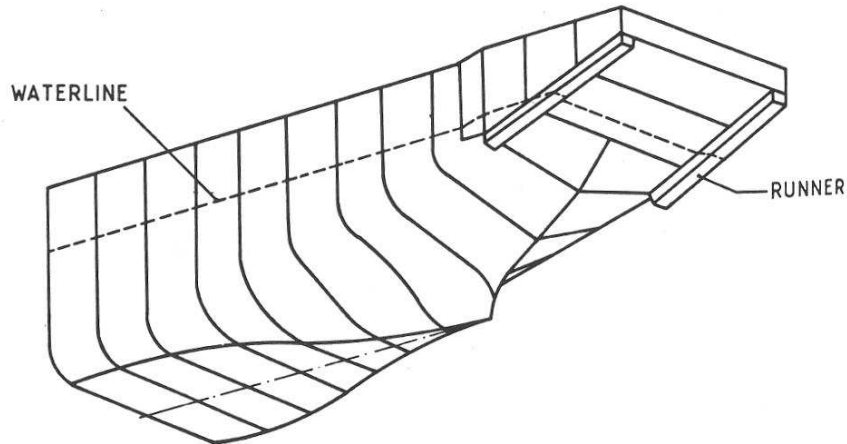

Figure 6: Thyssen-Wass Bow (*Max Waldeck* or *Mud'Yug*, taken from Peirce et al, 1987).

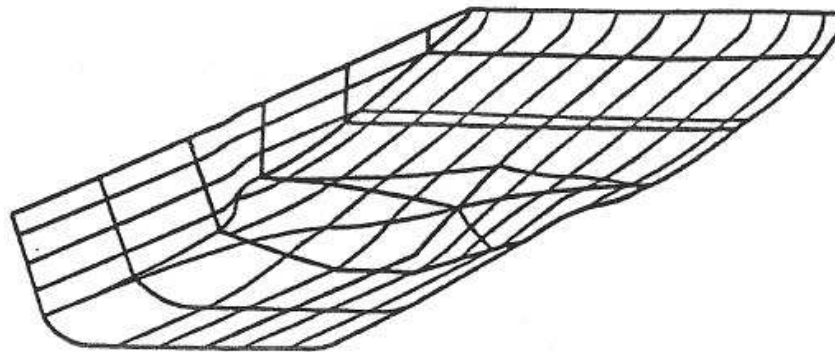

Figure 7: Square Bow (conventional, taken from Peirce et al, 1987).

2.3.2 Bow design considerations

Despite the extensive research and effort invested in the creation of existing variations in bow form, tests have shown that bow shape only indirectly influences a vessels icebreaking resistance during low speed continuous breaking (Yamaguchi, et al. 1997). Resistance associated with the action of breaking pieces off the parent ice sheet (icebreaking resistance) is normally considered the largest component in the resistance of ship-ice interaction. Tests show icebreaking resistance to be a function of total crack length per unit distance in ship advance direction (Yamaguchi, et al. 1997), such that

$$R_b = 0.0429\sigma_f h^2 l_{cr} \quad (1)$$

where R_b is the icebreaking resistance, σ_f is the flexural strength of the parent ice sheet, h is the ice thickness, and l_{cr} is the total crack length. Crack length is the length of the radial crack propagating from the bow. It has been shown to be directly proportional to bow stem angle, ϕ (Yamaguchi et al., 1997). Narita et al. (1981) also found that smaller bow angles result in lower resistance in ice.

Both Yamaguchi et al. (1997) and Narita, et al. (1981) were in agreement that spoon type bows with low stem angles offered the lowest resistance in ice. These bows were not compared against the Thyssen-Wass bow during their studies.

It is important to note that the bow that provides the least resistance in ice is not necessarily the best choice when designing an icebreaker (Narita et al., 1981). The bow should also be designed to prevent broken ice pieces from entering the propellers as a loss of power may result from the reduced propulsive efficiency.

2.3.3 Mid-body

Mid-body design centres either on mid-body side flaring or mid-body tapering.

The mid-body of a vessel must break ice while the vessel manoeuvres. Ships with parallel mid-body do not break ice very well because only a lateral icebreaking force is produced. Mid-body side flare adds a downward component to icebreaking by the sloped mid-body. This downward breaking component greatly improves the mid-body's icebreaking ability leading to better manoeuvrability.

An effective alternative to the mid-body side-flare is the mid-body taper. Mid-body taper has been used on the *Manhattan*, the *Canmar Kigoriak*, and many other ice transiting vessels. Mid-body taper is accomplished most easily through the introduction of "reamers" or "blisters" at the front shoulders of the vessel. Reamers and blisters widen the beam in the bow area so that the mid-body is effectually much narrower than the maximum beam. This allows room for the stern of the vessel to drift outward, pointing the bow into the turn. Because reamers and blisters remove the need for side-flare, difficulty and cost of icebreaker construction can be reduced because a vertical walled parallel mid-body can be utilized instead (Menon et al., 1991).

2.3.4 Aft-body

Resistance and manoeuvring performances during astern and ahead manoeuvres are the two main aspects improved by aft-body design. Advances in aft-body design have not progressed much further than incorporating an undercut and rounded stern. This reduces the amount of ice that gets sucked into the propellers and permits astern icebreaking during backing and turning circle manoeuvres.

Icebreaker aft-body design has not been subject to extensive research; however, the Hamburg Ship Model Basin (HSVA) has conducted some research with regard to aft-body hull appendages (Hellmann et al., 1992).

2.3.5 Hull appendages

2.3.5.1 Ice knife

The ice knife is a sharp protrusion usually found along the ship's centreline on the bottom of the hull where the bow and shoulders merge. The ice knife serves a dual purpose: it acts as a splitting edge for ice that has not yet failed in flexure, and it stops the icebreaker from riding too high upon the ice and possibly breaching.

2.3.5.2 Friction reducing systems

Friction reduction systems consist of air bubblers, hull wash systems, and friction reducing paint.

Air bubbling systems, i.e, the patented Wärtsilä Air Bubbling System, incorporate nozzles at the lower hull, forward of the chine. During icebreaking operations, compressed air is forced out of these nozzles and mixes with the water between the hull and the ice sheet. This serves to "lubricate" the hull-ice contact and greatly reduces friction at the interface. Bubblers have been proven effective (Browne et al., 1984; Peirce and Peirce, 1987; and Kannari and Humphries, 1987) and they are incorporated on a vast number of icebreakers, including the *M.V. Kalvik*, *USCGC Mobile Bay*, *CCGS Henry Larsen*, *CCGS Sir Humphrey Gilbert*, and *M.V. Arctic*.

Hull wash systems consist of water outlets located primarily at the bow, but may also be found around the entire circumference of the vessel. They are placed on the hull above the waterline. During icebreaking operations seawater, which is pumped through these outlets, falls between the ship's hull and the ice "lubricating" the hull-ice interface and thereby reducing friction. Hull wash systems are proven effective (Johansson and Liljeström, 1989 and Riska et al., 2001) and they are employed on the *USCGC Healy*, *Tor Viking II*, and *Oden*, to name a few.

Friction paint has long been used on non-icebreaking vessels as a means to reduce hull-water friction. Icebreaker friction paint serves the same purpose for water and ice frictions. The main difference is that icebreaker friction paint is much tougher so that it is not scraped off during the violent hull-ice interactions.

2.3.5.3 Podded icebreakers

With the recent development of azimuthing-podded propulsors, icebreaker design has entered a new realm. Traditional icebreakers were developed for “ahead” icebreaking with good astern icebreaking capability and moderate manoeuvrability. As technology advanced, bow forms were developed that could break thicker ice; however, these bows also inherited decreased open water performance as a result (Juurmaa et al., 2001). The early 1990’s saw the development of electric propulsors that could rotate 360° about a vertical axis. These propulsors were incorporated on existing ice transiting vessels for testing and field operation (Juurmaa et al., 2001). New designs also appeared that took icebreaking hull design to a new level.

A comprehensive discussion of azi-pod icebreakers is beyond the scope of this work; however, the current trends in this technology involve the double acting and oblique hull forms.

The double acting hull form combines two bow shapes and a podded propulsion system in one ship. An ice-strengthened “open-water” bow (sometimes incorporating a bulbous bow) is designed for the summer months where scattered multi-year ice may be encountered. The “stern” bow is designed for more serious icebreaking such as ridge ramming. The directional thrust ability of the podded propulsors enables the use of either bow with equal facility.

The oblique hull form incorporates a more rounded hull form that allows ice breaking “abreast” (Juurmaa et al., 2001) in addition to more traditional ice breaking “ahead” or “astern”. Abreast icebreaking involves moving laterally and breaking ice with the port or starboard side as opposed to the bow or stern. Abreast icebreaking provides a very large broken ice channel that is approximately equal to the icebreakers waterline length.

Podded propulsion allows for abilities that are vast improvements over traditional icebreakers including: turning 180° on-the-spot, icebreaking with the propeller wake, faster crash stops while maintaining directional control, and fast and tight turns from full speed ahead (Juurmaa et al., 2001).

2.3.5.4 Traditional propulsion/rudder arrangements

Propeller/rudder arrangements have a direct impact on a ship’s ability to manoeuvre in ice. Vessels that have their rudders placed directly in a propeller race have a distinct manoeuvring advantage over those that do not (Peirce and Peirce, 1987). For a vessel in the latter category this is partly due to the fact that there is very little flow over the rudder when the vessel is manoeuvring at low speed. The advantage of having a propeller in the propeller race is that there is always significant flow over the rudder while the screws are turning regardless of the ship’s speed.

Varying the rudder size and its position relative to the propeller race are also important design criteria. The useful size of a rudder is partly a function of its position (Peirce and Peirce, 1987).

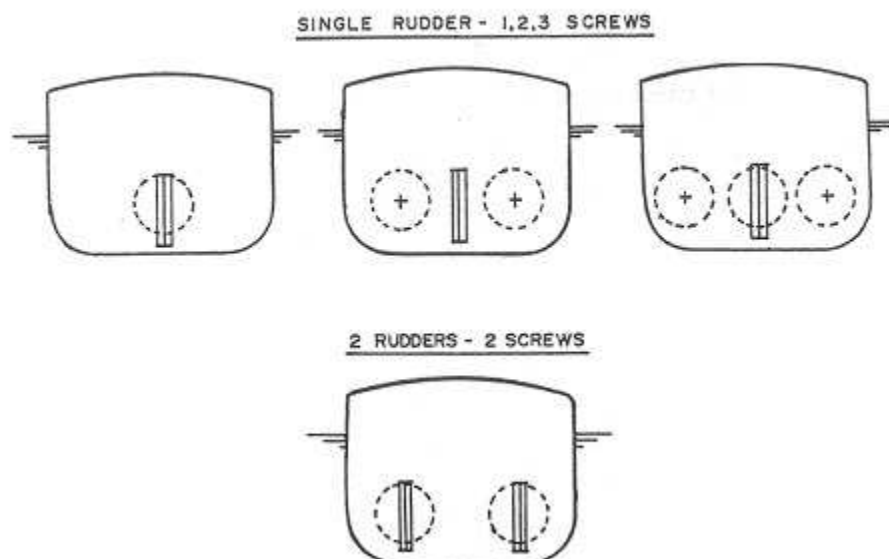

Figure 8: Traditional Screw/Rudder Arrangements (Peirce and Peirce, 1987).

The traditional propeller/rudder configurations are given in Figure 8. They include: single screw/single rudder, twin screw/single rudder, twin screw/twin rudder and triple screw/single rudder.

Vessels with a single screw/single rudder arrangement are usually cargo/tanker vessels that operate in ice-infested waters. Vessels such as *M.V. Arctic*, *M.V. Arctic Ivik*, and *SA-15* employ this screw/rudder arrangement. A single screw can reduce the problem of constant ice milling. Single screw/single rudder vessels generally have better manoeuvrability than twin screw/single rudder vessels.

The twin screw/single rudder design is popular with Canadian Coast Guard icebreakers (e.g. *Terry Fox* and *Ann Harvey*). It is also found on the German *Polarstern*. It offers less resistance to astern motion than a twin screw/twin rudder arrangement, but does not manoeuvre as well because the single rudder cannot produce comparable steering forces, especially at low speed.

The twin screw/twin rudder arrangement provides better manoeuvrability than both twin screw/single rudder and triple screw/single rudder arrangements (Menon et al., 1991). According to Menon et al. (1991), vessels of this arrangement perform better without reamers, than with them. Maximum rudder force for this arrangement is also greater than that of a twin screw/single rudder arrangement, even for identical rudder areas. This arrangement experiences higher astern resistance than the twin screw/single rudder arrangement (Hellmann and Valanto, 1992).

The triple screw/single rudder type of arrangement can be found on vessels including *John A. MacDonald*, *Louis St.-Laurent*, *Polar Star*, and *Polar Sea*. The power produced by the three shafts provides high rudder loading and, hence, good manoeuvrability. These vessels generally have better manoeuvrability than vessels equipped with a twin shaft/single rudder arrangement.

2.4 Manoeuvres in Ice

The main objective of this review is to perform an extensive literature search to identify all publicly available full- and model-scale ship-ice manoeuvring data collected to-date. Test data was collected and catalogued according to full-scale, “free running” model scale, and captive model scale tests. Common to these three types of tests is the necessity of recording all environmental conditions prevalent during the tests. Typical measurements are ice thickness, ice flexural strength, snow cover and windage (full-scale only).

2.4.1 Full-scale ice manoeuvring

Common manoeuvres conducted by icebreaking vessels are: (1) Ahead progress, (2) Channel breakout, (3) Turning circle, (4) Captain’s turn, (5) Modified Captain’s turn, (6) Kempf Manoeuvre (or zig-zag), (7) Breaking out a beset vessel, (8) Close coupled escort and (9) Ridge ramming. The turning circle and the Kempf manoeuvres are the most common of all in a “manoeuvring in ice” performance evaluation.

2.4.1.1 Turning circle

The turning circle is used to turn a full-scale vessel 180° when space and obstacles are not a problem.

Figure 9 shows a schematic of the turning circle manoeuvre. It can be broken up into 4 phases: The approach phase, the first phase, the second phase, and the third phase. During the approach phase, the vessel progresses straight ahead with rudder angle, sway acceleration, sway velocity, yaw acceleration, and yaw rate all equal to zero. The first phase commences with the start of the change in rudder angle and finishes when the rudder reaches the desired rudder position. During this phase the sway and yaw accelerations start to increase while the sway velocity and yaw rate are negligible. The second phase is non-steady state and is characterized by changing sway acceleration, sway velocity, yaw acceleration, and yaw rate. As the second phase matures, the third and final phase commences when the sway and yaw accelerations decrease to zero and the sway velocity and yaw rate tend to constant values.

Steady turning radius is the traditional and simplest measure of a vessel’s manoeuvrability. The steady turning radius is measured from the steady-state portion of the turning circle (Phase 3). Steady turning radius (R) is usually non-dimensionalized with the ship’s waterline length (L_{WL}) as R/L_{WL} , or R/L for simplicity. Because variations

in ice thickness and strength also affect the vessel's manoeuvrability, R/L is not as reliable a representative of "manoeuvring performance in ice" as it is for open water.

An attempt to establish a more reliable descriptor has been made by Menon et al. (1991), called the *Steady Turning Performance Index* (STPI), but R/L is still widely used by most authors. Generally the smaller the R/L value for a vessel, the greater its ability to manoeuvre while remaining in continuous motion.

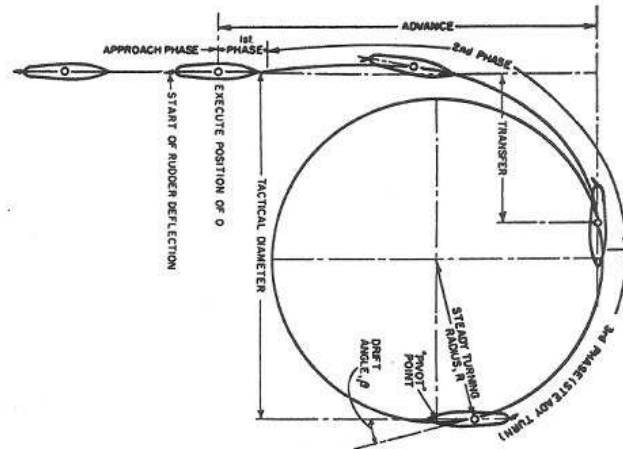

Figure 9: Turning Circle Schematic (Kendrick et al., 1984).

2.4.1.2 Kempf manoeuvre

The Kempf manoeuvre is used to quantify the rapidity of a vessel's response to dynamic rudder variations. This information provides insight into a vessel's ability to avoid obstructions. Figure 10 shows a schematic of the Kempf manoeuvre. It is essentially a zig-zag manoeuvre where the vessel's rudder is dynamically cycled to induce sinusoidal vessel motions. The steady turning radius is measured from the crests and troughs of the path traced out by the vessel in ice. As with the turning circle, the steady turning radius is the standard measure of performance for the Kempf manoeuvre.

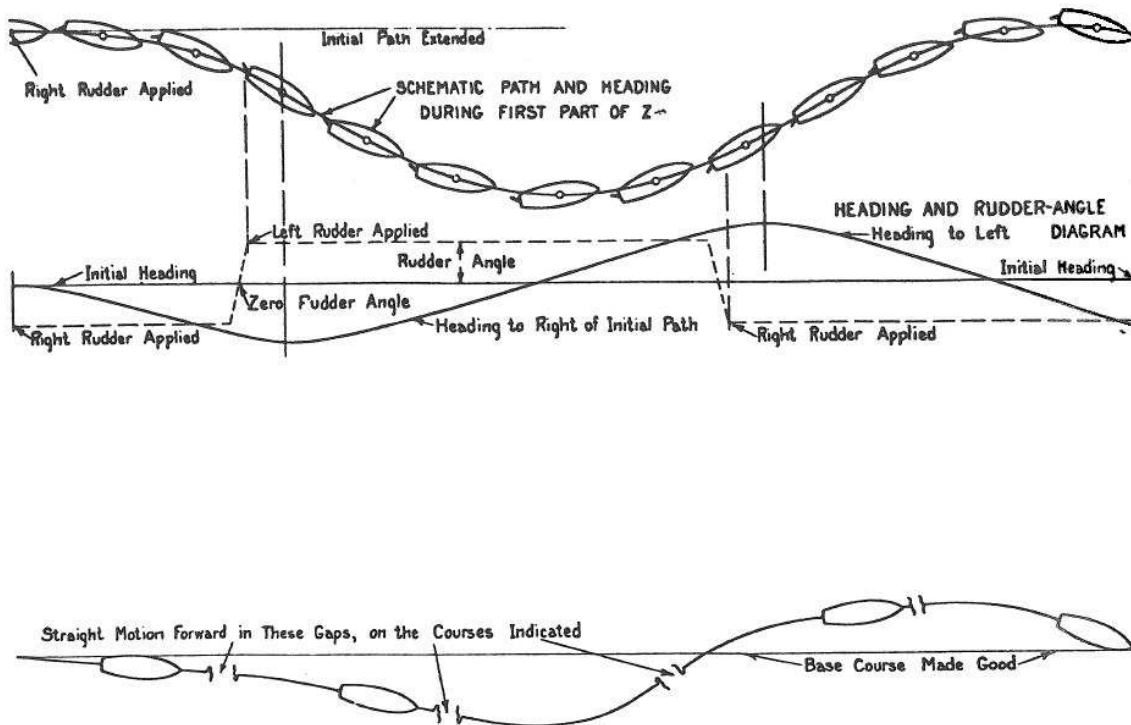

Figure 10: Kempf Manoeuvre Schematic (reproduced from Kendrick et al., 1984).

2.4.1.3 Other common manoeuvres

Ahead progress refers to the manoeuvre when the vessel making steady progress in various ice conditions and thicknesses, whereas the channel breakout refers to the manoeuvre when the vessel breaks out of a previously broken channel in part of, or in preparation for another manoeuvre.

The Captain's turn is used when manoeuvring space is limited: The vessel turns around 180° by performing a series of channel breakouts fore and aft (see Figure 11).

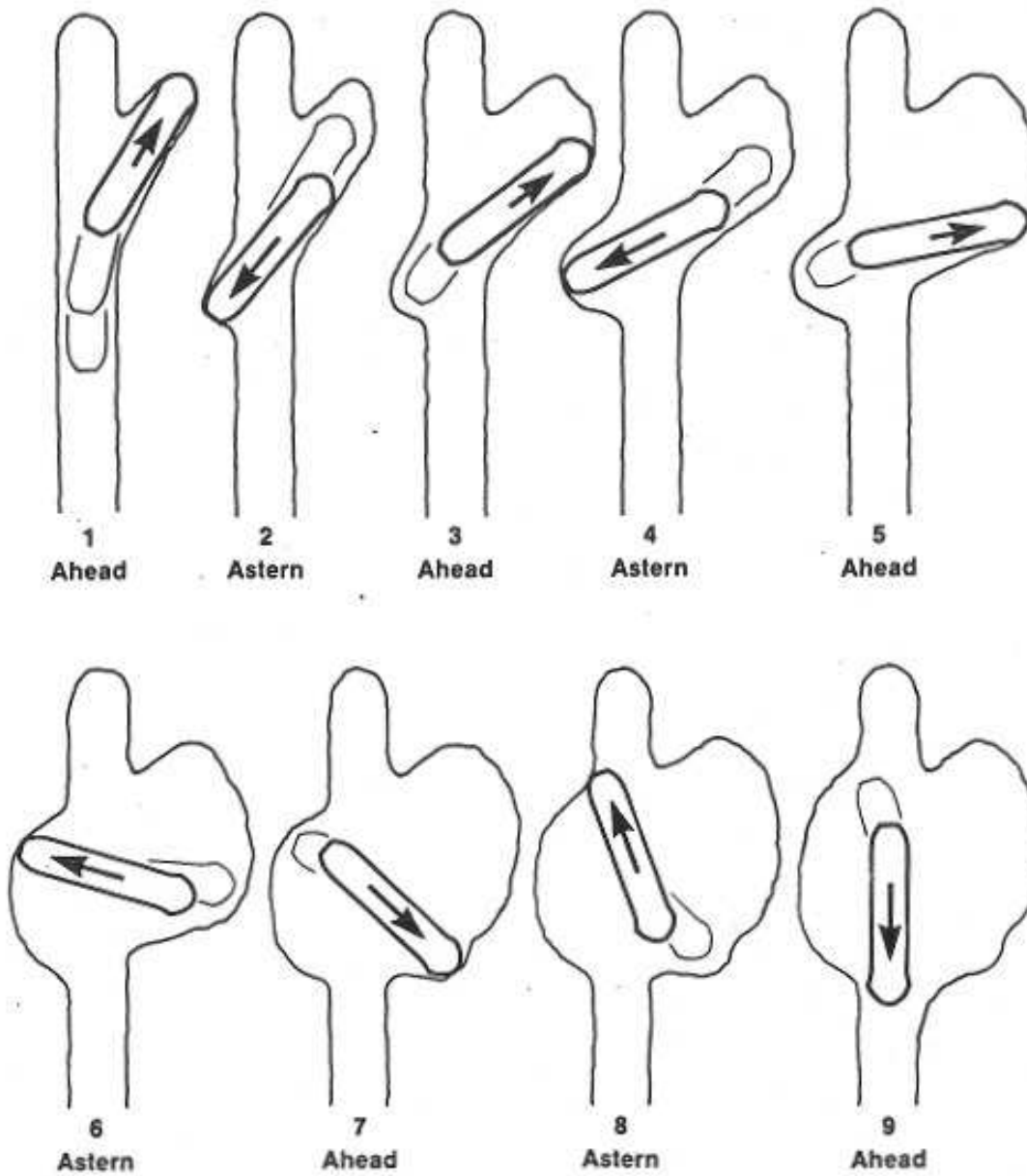

Figure 11: Captain's Turn (Tue-Fee, 1985).

The modified Captain's turn is an improvement on the Captain's Turn: The Modified Captain's Turn is used to turn 180° in a restricted area but with fewer motions (see Figure 12).

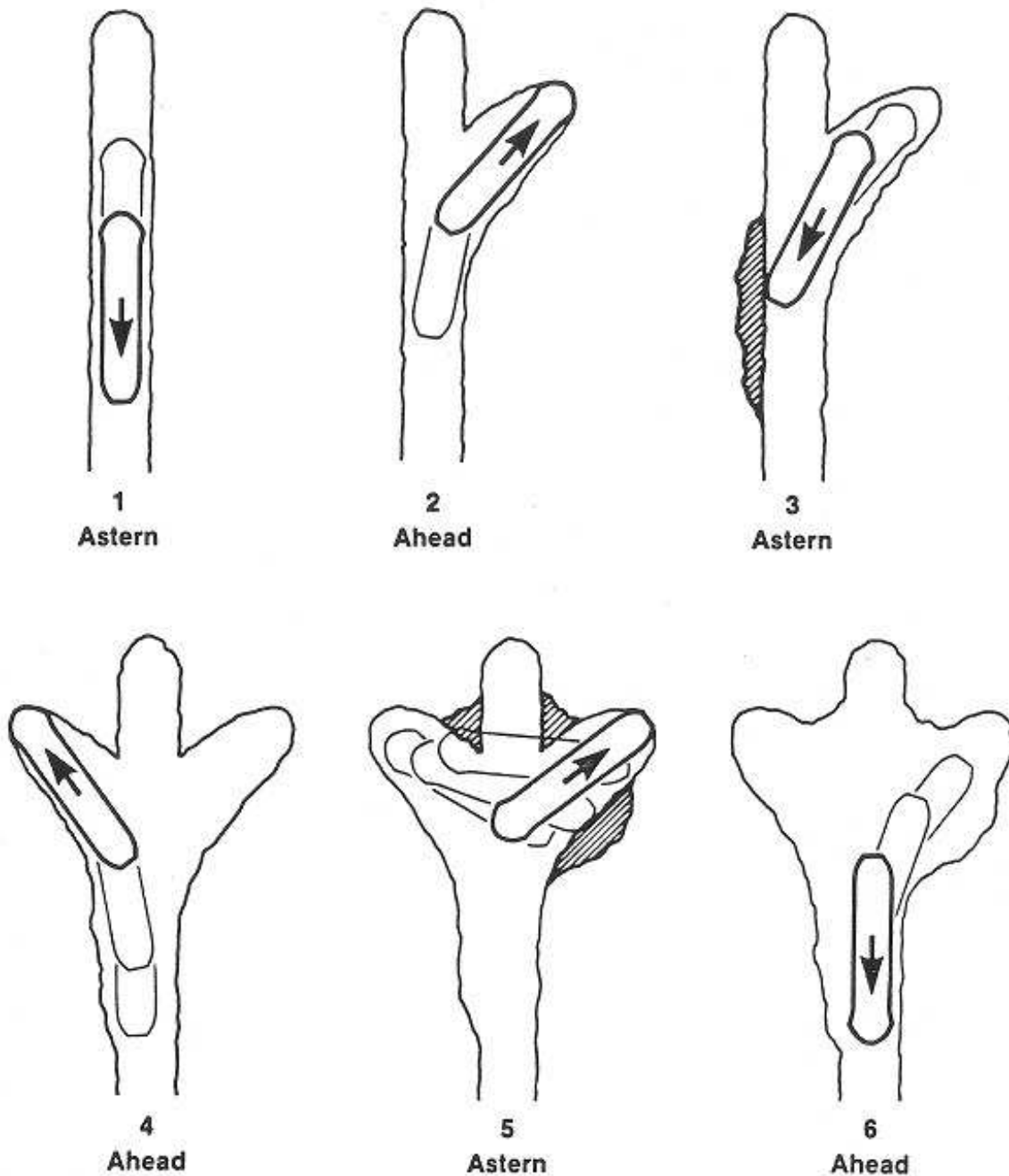

Figure 12: Modified Captain's Turn (Tue-Fee, 1985).

If the environmental conditions are more severe (e.g. thick ice or ice under pressure), an icebreaker will use a series of the fore-mentioned manoeuvres to "break out" a vessel that is stuck in the ice. For example, if the ice is under pressure from wind, an icebreaker might perform a turning circle around the beset vessel - to relieve the pressure - and then break the ice astern and ahead of the beset vessel to free it.

When an icebreaker encounters an ice ridge, it often will not be able to continue through it in a steady icebreaking motion. Progress through ridges is made by ramming them with the bow and stern of the vessel. This operation is referred to as ridge ramming.

The close coupled escort manoeuvre involves the icebreaker towing a crippled ship through various ice conditions.

2.4.1.4 Auxiliary manoeuvres

Ship manoeuvrability may also be improved by techniques such as heeling, duck walk, or strategic uses of bow thrusters and bubblers.

Heeling causes a change in the flare angles on either side of the vessel that results in a differential resistance across the bow. The vessel tends to turn toward the side with the least resistance. The direction of heel depends on the vessel's hull shape: Vessels having a conventional icebreaking bow with relatively constant flare angles at the waterline, i.e., *Canmar Kigoriak*, would probably benefit from inward (toward the centre of the turn) heeling, while vessels having a bow with a hard chine that may be submerged by heeling, i.e. *Robert LeMeur*, would probably benefit from outward heeling (Peirce and Peirce, 1987).

When a vessel is breaking thick ice or is stuck in the ice, it can gain extra icebreaking potential by performing a "Duck Walk". A "Duck Walk" is executed using the vessel's heeling system to roll the ship back and forth cyclically. This motion aids in asymmetry to the hull and facilitates the vessel's sides in breaking ice.

During turning manoeuvres, a bow thruster may be used to add steering force to decrease the vessels turning radius; however, it has been found that "impulse type" bow thrusters suffer from ice piece blockage and a loss of thrust with forward ship speed. "Reaction type" bow thrusters do not suffer these effects and therefore are more suitable for "manoeuvring in ice" (Peirce and Peirce, 1987).

Bubblers can be used like thrusters during turning manoeuvres by selectively feeding air to nozzles on one side of the vessel. The effect is significant in open water, but less so when turning in ice (Peirce and Peirce, 1987).

2.4.2 Model-scale ice manoeuvring

Ice manoeuvre tests in model scale can be grouped into two catalogues: "free running" model test and captive model test.

2.4.2.1 Free manoeuvre tests

The free manoeuvre tests involve the use of a remotely operated model that is unrestricted and capable of self-propulsion and steering. An operator directs the model via remote control and a model tracking system records its motions. The basic premise

of “free running” model testing is that any full-scale manoeuvres can be performed at model-scale via the application of scaled thrusts and rudder forces.

Two manoeuvres in particular are used to test the manoeuvring performance of free running models in ice: turning circles, and Kempf manoeuvres. Ideally, these manoeuvres are performed exactly as outlined in Section 2.4.1 for full-scale performance tests. While there is usually sufficient space in an ice tank to complete a Kempf manoeuvre, the scale of most models are too large to allow completion of a full turning circle manoeuvre.

Free running turning circle manoeuvres are usually completed by placing the model on one side of the ice sheet, applying the set power, and then applying the rudder when the model reaches a steady-state forward motion. The model completes about ¼ of a turning circle and the radius is measured from this portion.

2.4.2.2 Captive manoeuvre tests

Captive manoeuvre tests involve the use of some form of Planar Motion Mechanism (PMM) or a combination of devices that produce the same motion control (e.g. a rotating arm in combination with other devices). The Institute for Ocean Technology (IOT) has performed a large number of model tests using its PMM (Marineering Limited, 1997). A substantial amount of manoeuvring test data contained in this database were extracted from IOT’s test database; hence, a brief description of the types of PMM tests performed in IOT’s facility is given in this section for quick reference. Please refer to the fore-mentioned reference for details.

Set-Up

The model is rigidly attached to the PMM, which is rigidly attached to the ice tank carriage. The carriage controls the model’s surge motion, and the PMM controls the model’s yaw and sway motions, so to produce a desired planer motion. The model’s heave and pitch motions are unrestricted. The basic premise of PMM testing is that the hydrodynamic and ice derivatives (as described in the following sub-section) governing the manoeuvring performance of a vessel can be determined by forcing the model to perform predetermined prescribed motions and recording the resulting forces and moments (Marineering Limited, 1997). Vessel manoeuvring characteristics can then be predicted.

Equations of Motion

The general manoeuvring equations governing the motions of a vessel are given as follows:

$$-Y'_v \dot{v}' - (m' - Y'_v) \dot{v}' - (Y'_r - m') r' - (Y'_r - m' x'_G) \dot{r}' = Y'_\delta \delta \quad (2)$$

$$-N'_v \dot{v}' - (N'_v - m' x'_G) \dot{v}' - (N'_r - m' x'_G) r' + (I'_z - N'_r) \dot{r}' = N'_\delta \delta \quad (3)$$

where:

$$m' = \frac{m}{\frac{\rho}{2} L^2 T} \quad \text{Non-dimensional ship mass}$$

$$I'_z = \frac{I_z}{\frac{\rho}{2} L^4 T} \quad \text{Non-dimensional ship heave mass moment of inertia} \quad ^1$$

$$v' = \frac{v}{V} \quad \text{Non-dimensional ship sway velocity}$$

$$\dot{v}' = \frac{\dot{v}}{V} \quad \text{Non-dimensional ship sway acceleration}$$

$$r' = \frac{rL}{V} \quad \text{Non-dimensional ship yaw rate}$$

$$\dot{r}' = \frac{\dot{r}L^2}{V^2} \quad \text{Non-dimensional ship yaw acceleration}$$

$$\delta' = \delta \quad \text{Non-dimensional ship rudder angle}$$

$$Y'_v = \frac{Y_v}{\frac{\rho}{2} LTV} \quad \text{Non-dimensional derivative of } Y \text{ due to } v$$

$$N'_v = \frac{N_v}{\frac{\rho}{2} L^2TV} \quad \text{Non-dimensional derivative of } N \text{ due to } v$$

$$Y'_{\dot{v}} = \frac{Y_{\dot{v}}}{\frac{\rho}{2} L^2T} \quad \text{Non-dimensional derivative of } Y \text{ due to } \dot{v}$$

$$N'_{\dot{v}} = \frac{N_{\dot{v}}}{\frac{\rho}{2} L^3T} \quad \text{Non-dimensional derivative of } N \text{ due to } \dot{v}$$

$$Y'_r = \frac{Y_r}{\frac{\rho}{2} L^2TV} \quad \text{Non-dimensional derivative of } Y \text{ due to } r$$

$$N'_r = \frac{N_r}{\frac{\rho}{2} L^3TV} \quad \text{Non-dimensional derivative of } N \text{ due to } r$$

$$Y'_{\dot{r}} = \frac{Y_{\dot{r}}}{\frac{\rho}{2} L^3T} \quad \text{Non-dimensional derivative of } Y \text{ due to } \dot{r}$$

¹ Marineering Limited, 1997, P 14 reported this as $I'_z = \frac{I_z}{\frac{\rho}{2} L^3 T}$ which is not non-dimensional.

$$N'_r = \frac{N_r}{\frac{\rho}{2} L^4 T} \quad \text{Non-dimensional derivative of } N \text{ due to } \dot{r}$$

$$Y'_\delta = \frac{Y_\delta}{\frac{\rho}{2} L T V^2} \quad \text{Non-dimensional derivative of } Y \text{ due to } \delta$$

$$N'_\delta = \frac{N_\delta}{\frac{\rho}{2} L^2 T V^2} \quad \text{Non-dimensional derivative of } N \text{ due to } \delta$$

m	Ship mass
I_z	Ship heave mass moment of inertia
v	Sway velocity (lateral speed) [m/s]
\dot{v}	Sway acceleration (lateral acceleration) [m/s ²]
r	Yaw rate [rad/s]
\dot{r}	Yaw acceleration [rad/s ²]
x_G	Position of centre of gravity [m]
I_z	Yaw moment of inertia [kg-m ²]
δ	Rudder angle [degrees]
ρ	Mass density of water [kg/m ³]
L	Ship length (L _{WL}) [m]
T	Ship draft [m]
V	Ship speed (forward) [m/s]
Y_v	Derivative of sway force due to sway velocity [kg/s]
N_v	Derivative of yaw moment due to sway velocity [kg-m/s]
$Y_{\dot{v}}$	Derivative of sway force due to sway acceleration [kg]
$N_{\dot{v}}$	Derivative of yaw moment due to sway acceleration [kg-m]
Y_δ	Derivative of sway force due to rudder angle [kg-m/s ²]
N_δ	Derivative of yaw moment due to rudder angle [kg-m ² /s ²]
Y_r	Derivative of sway force due to yaw rate [kg-m/s]
N_r	Derivative of yaw moment due to yaw rate [kg-m ² /s]
$Y_{\dot{r}}$	Derivative of sway force due to yaw acceleration [kg-m]
$N_{\dot{r}}$	Derivative of yaw moment due to yaw acceleration [kg-m ²]

These equations of motion have been derived for model ship manoeuvring in ice based on a series of assumptions (Marineering Limited, 1997):

- Higher order derivatives are ignored, but can be easily included if necessary.
- The model's centre of gravity is assumed to be on the model's centreline; therefore y_G (distance to lateral centre of gravity from model's centreline) is assumed to be zero.

- The model is assumed to be symmetrical along the centreline so that Y_u and Y'_u are assumed to be zero.

The different types of controlled manoeuvres are summarized in Figure 13.

2.4.2.2.1 Standard PMM tests and turning circle numerical modeling

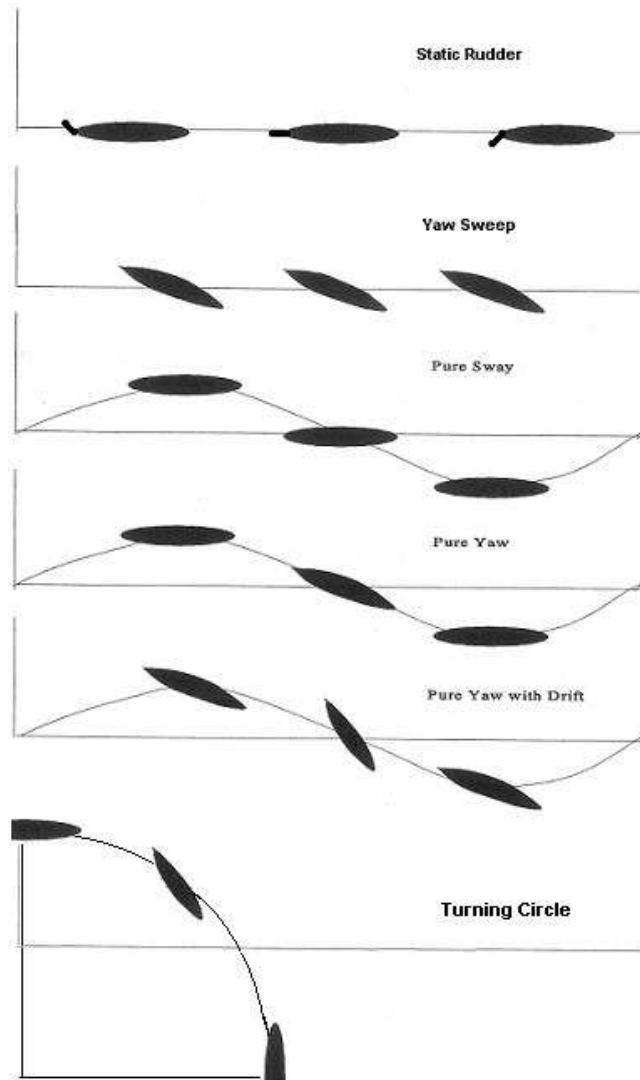

Figure 13: Standard PMM Tests (modified from Marineering Limited, 1997).

Static Rudder Tests

The model is fixed straight ahead and the rudder is moved from hard port to hard starboard in discrete increments as the model is towed down the tank at its self-propulsion speed (to ensure proper flow around the stern). The ice derivatives, X_δ , Y_δ and N_δ are found by plotting X , Y , and N , respectively, versus δ . If the plots are highly non-linear, a higher order fit should be applied and the above equations of motion

modified. The effect of ship speed can be determined by performing these tests for a range of speeds.

Yaw Sweep Tests

Yaw sweep tests are performed by fixing the model at a drift angle, β (about the vertical axis), to the direction of motion. This induces a lateral flow component on the hull described by $v = -V \sin \beta$, where V = Ship's forward speed (m/s), v = Lateral speed [m/s], and β = drift angle. A plot of X , Y , and N versus v yields Y_v and N_v (also found from pure sway tests).

Pure Sway Tests

The pure sway test is performed by fixing the model's heading (e.g. $\beta=0$) and moving the carriage down the tank at a fixed speed while swaying the model in a sinusoidal pattern of amplitude, Y_o , and period, τ . This motion produces a variable lateral cross flow and the resulting forces and moments are due to the model's velocity and acceleration. This motion can be parametrically described by:

$$x = Vt \quad (4)$$

$$y = Y_o \cos \omega t \quad (5)$$

$$\phi = 0 \quad (6)$$

$$\omega = \frac{2\pi}{\tau} \quad (7)$$

Where:

- x = surge position
- y = sway position
- Y_o = sway amplitude
- ω = circular frequency
- t = time
- ϕ = yaw angle
- τ = period of oscillation

Performing this test at various speeds, V , and periods, τ , will produce a variation in lateral speed, v . Y_v , $Y_{\dot{v}}$, N_v and $N_{\dot{v}}$ are found by performing a Fourier analysis on the lateral force and yaw moment, and plotting the sway amplitudes against the sway velocity amplitude. Note: $Y_{\dot{v}}$ is the inertial swaying load that is equal to the mass of the model plus its added mass in sway.

Pure Yaw Tests

The pure yaw test is similar to the Kempf manoeuvres in the free-run tests. In this test, the model is rotated during manoeuvre so that its heading is always tangent to the sway path according to:

$$\dot{x} = V \quad (8)$$

$$\dot{y} = -Y_o \omega \sin(\omega t) \quad (9)$$

$$\phi = \tan^{-1} \left[\frac{-Y_o \omega}{V} \sin(\omega t) \right] \quad (10)$$

$$r = \frac{d\phi}{dt} = -\frac{Y_o \omega^2 V}{V^2 + v^2} \cos(\omega t) \quad (11)$$

Where: $\dot{x} = V =$ surge velocity
 $\dot{y} = v =$ sway velocity
 $Y_o =$ sway amplitude
 $\omega =$ circular frequency
 $t =$ time
 $\phi =$ yaw angle
 $r =$ yaw rate

Because the heading is always tangent to the path, sway velocity, v , is equal to zero; therefore the model experiences only a variable rotational flow. The resulting forces and moments are the result of the rotational velocity and acceleration. Testing a number of velocities, V , and periods, τ , yields a variation in yaw rate, r . The derivatives, Y_r , $Y_{\dot{r}}$, N_r and $N_{\dot{r}}$ are found by performing a Fourier analysis on the lateral force and yaw moment, and plotting the amplitudes against the yaw rate amplitude.

Pure Yaw with Drift

These tests are performed to determine cross flow derivatives. They are performed over a range of drift angles and consist of a combination of the pure yaw and static drift tests described above. In this manoeuvre, the model experiences a pure yawing motion with a constant lateral cross-flow velocity. The yaw angle is given by:

$$\phi = \tan^{-1} \left[\frac{Y_o \omega}{V} \sin(\omega t) \right] + \beta \quad (12)$$

Where: $\beta =$ drift angle

Turning Circle Tests

The response of a ship to the deflection of its rudder(s) and the resulting forces and moments produced by the rudder(s) can be divided into an initial transient phase and a static phase. The transient phase occurs at the initiation of a turn and persists until the surge, sway, and yaw accelerations go to zero. At this time the manoeuvre enters the static phase, which is characterized by constant surge, sway, and yaw velocities. The steady turning radius is measured (or predicted) during the static turning phase.

Turning Circle Predictions

Once the coefficients of the equations of motion for the model are known, its turning circle can be predicted for either open water or ice.

For open water turning circle tests, \dot{v} and \dot{r} are equal to zero, therefore from equations 2 and 3 respectfully:

$$-Y'_v v' - (Y'_r - m')r' = Y'_\delta \delta \quad (2a)$$

$$-N'_v v' - (N'_r - m'x'_G)r' = N'_\delta \delta \quad (3a)$$

Since $R=V/r$ and $r' = \frac{rL}{V}$, then $r' = \frac{L}{R}$. Then solving 2a and 3a simultaneously and substituting $r' = \frac{L}{R}$ yields:

$$\frac{R}{L} = -\frac{1}{\delta} \left[\frac{Y'_v(N'_r - m'x'_G) - N'_v(Y'_r - m')}{Y'_v N'_\delta - N'_v Y'_\delta} \right] \quad (13)$$

Note: See pages 19 and 20 for variable definitions.

For turning circles in ice, Y'_v is much greater than N'_v because the force acts approximately at amidships. Further, if x_G is ignored then the above equation reduces to:

$$\frac{R}{L} = -\frac{1}{\delta} \left[\frac{N'_r}{N'_\delta} \right] \quad (14)$$

or

$$R = -\frac{V}{\delta} \left[\frac{N'_r}{N'_\delta} \right] \quad (15)$$

Note: See pages 19 and 20 for variable definitions.

3.0 THE DATABASE

Manoeuvring tests published after 1995 were found during the literature review and their data was collected from 20 individual reports: Including 24 full-scale manoeuvring trial series, 11 “free running” model test series, and 3 “captive” model test series. Data published prior to 1995 was already consolidated in a database called the “Ship in Ice Performance Database Version 1.0”. It was not possible to validate the data in this database during the required timeframe and its quality is taken on trust.

The current “Manoeuvring in Ice” database is broken into three spreadsheets: FULL SCALE – MANOEUVRES, MODEL SCALE – MANOEUVRES, AND PMM MODEL SCALE MANOEUVRES. Each spreadsheet contains data on a vessel’s “manoeuvring in ice” performance, based on the types of tests conducted on that vessel.

3.1 Types of Data Reported

The most common types of data and functional relationships reported by the majority of authors were entered into the database for each type of test.

3.1.1 Full-scale manoeuvring trials data types

The most common data types reported for full-scale manoeuvring trials were:

- SNOW_DEPTH [m] Depth of snow cover on ice – There is also a grading system for the type of snow cover, but few reports included this parameter so it was not included in the database.
- BUBBLER Indicates tests with bubbler turned “ON” or “OFF”
- PORT_SHAFT_SPEED [rps] Port propeller shaft speed (if applicable)
- STBD_SHAFT_SPEED [rps] Starboard propeller shaft speed (if applicable)
- MID_SHAFT_SPEED [rps] Centre propeller shaft speed (for 1 or 3 shafts)
- PORT_THRUST [N] Port propeller thrust (if applicable)
- STBD_THRUST [N] Starboard propeller thrust (if applicable)
- MID_THRUST [N] Centre propeller thrust (for 1 or 3 shafts)
- TOTAL_THRUST [N] Total thrust from all shafts
- PORT_SHAFT_POWER [kW] Port shaft power (if applicable)
- STBD_SHAFT_POWER [kW] Starboard shaft power (if applicable)
- MID_SHAFT_POWER [kW] Centre shaft power (for 1 or 3 shafts)
- SPEED [m/s] Ship’s speed
- RECKONED_SPEED [m/s] Calculated ship’s speed
- RUDDER_ANG [deg] Rudder angle
- TC_RADIUS [m] Turning circle radius
- R/L Non-dimensionalized turning circle radius
- HEEL_ANG [deg] Ship’s heel angle (“-“ for no heel)
- TIME_TO_TURN_180_DEG [s] Time for ship to turn 180°

3.1.2 “Free running” model tests

The most common data types reported for “free-running” model-scale manoeuvring tests were:

- SCALE Model scale
- PORT_SHAFT_SPEED [rps] Port propeller shaft speed (if applicable)
- STBD_SHAFT_SPEED [rps] Starboard propeller shaft speed (if applicable)
- MID_SHAFT_SPEED [rps] Centre propeller shaft speed (for 1 or 3 shafts)
- PORT_THRUST [N] Port propeller thrust (if applicable)
- STBD_THRUST [N] Starboard propeller thrust (if applicable)
- MID_THRUST [N] Centre propeller thrust (for 1 or 3 shafts)
- PORT_TORQUE [Nm] Port shaft torque (if applicable)
- STBD_TORQUE [Nm] Starboard shaft torque (if applicable)
- MID_TORQUE [Nm] Centre shaft torque (for 1 or 3 shafts)
- SPEED [m/s] Model speed
- CALC_SPEED [m/s] Calculated model speed
- PORT_RUDDER_ANG [deg] Port rudder angle for twin rudder models
- STBD_RUDDER_ANG [deg] Starboard rudder angle for twin rudder models
- MID_RUDDER_ANG [deg] Rudder angle for single rudder models
- TC_RADIUS [m] Model turning circle radius
- R/L Non-dimensionalized turning circle radius
- TIME_TO_TURN_180_DEG [s] Calculated time for model to turn 180°
- DRIFT_ANG [deg] Angle between turning circle path and centreline measured at the models centre of gravity
- YAW_RATE [deg/s] Rate of change of yaw angle
- HEEL_ANGLE [deg] Heel angle of model

3.1.3 “Captive” model tests

The most common data types for “captive” model-scale manoeuvring tests were:

- SCALE Model scale
- ROUGHNESS [mm] Model hull roughness
- TEST_TYPE “Standard PMM (see 2.4.2.2.1)” tests or “Turning Circle” or “Sinusoidal” tests
- MAX_YAW_RATE [deg/s] Maximum rate of change of yaw angle
- SWAY VEL [m/s] Model lateral velocity
- TC_RADIUS [m] Model turning circle radius
- Y_v [kg/s] – SWAY Sway force due to sway velocity derivative
- Y_v [Non-Dim] – SWAY Non-dimensional sway force due to sway velocity derivative
- Y_v' [kg] – SWAY Sway force for sway acceleration derivative

- Y_v' [Non-Dim] – SWAY Non-dimensional sway force for sway acceleration derivative
- Y_{pmm} [N] Sway force felt by PMM
- N_v [kg-m/s] – SWAY Turning moment due to sway velocity derivative (found from sway tests)
- N_v [Non-Dim] – SWAY Non-dimensional turning moment due to sway velocity derivative (found from sway tests)
- N_v' [kg-m] – SWAY Turning moment due to sway acceleration derivative
- N_v' [Non-Dim] – SWAY Non-dimensional turning moment due to sway acceleration derivative
- N_{pmm} [N-m] Turning moment felt by PMM
- N_r [kg-m²/s] – YAW Turning moment due to yaw rate derivative
- N_r [Non-Dim] – YAW Non-dimensional turning moment due to yaw rate derivative
- N_r' [kg-m²] – YAW Turning moment due to yaw acceleration derivative
- N_r' [Non-Dim] – YAW Non-dimensional turning moment due to yaw acceleration derivative
- Y_r [kg-m/s] – YAW Sway force due to yaw rate derivative
- Y_r [Non-Dim] – YAW Non-dimensional sway force due to yaw rate derivative
- Y_r' [kg-m] – YAW Sway force due to yaw acceleration derivative
- Y_r' [Non-Dim] – YAW Non-dimensional sway force due to yaw acceleration derivative
- N_v [kg-m/s] – DRIFT Turning moment due to sway velocity derivative (found from drift tests)
- N_v [Non-Dim] – DRIFT Non-dimensional turning moment due to sway velocity derivative (found from drift tests)
- Y_v [kg/s] – DRIFT Sway force due to sway velocity derivative (found from drift tests)
- Y_v [Non-Dim] – DRIFT Non-dimensional sway force due to sway velocity derivative (found from drift tests)
- m [kg] – WEIGHING Model mass
- m [Non-Dim] – WEIGHING Non-dimensional model mass
- I [kg-m²] – SWINGING Model mass moment of inertia
- I [Non-Dim] – SWINGING Non-dimensional model mass moment of inertia
- N_r ICE [kg-m²/s] Turning moment due to yaw rate in ice derivative
- N_r' ICE [kg-m²] Turning moment due to yaw acceleration in ice derivative

3.1.4 Common data types

Data types common to all full- and model-scale tests:

- VESSEL_ID Database vessel reference number
- VESSEL_NAM Name of the vessel being tested
- DATE Test date
- LOCATION Test geographic location
- TEST_ID Number to identify individual test results
- FRICT_COEFF Hull-ice interface friction coefficient
- ICE_COND Ice sheet condition (e.g. level ice)
- H_ICE [m] Ice thickness
- H_FLEX [Pa] Ice flexural strength
- PORT_STARB Turning circle direction to either port or starboard

- LWL [m] Ship/model waterline length during test
- LBP [m] Ship/model length between perpendiculars
- BEAM [m] Ship/model maximum beam
- BEAM_LWL [m] Ship/model maximum waterline beam
- DRAFT_MID [m] Ship/model draft at amidships
- DRAFT_FOR [m] Ship/model draft at forward perpendicular
- DRAFT_AFT [m] Ship/model draft at aft perpendicular
- DISPLACE [tonnes] Ship/model displacement
- WATER_DENSITY [kg/m³] Density of water during test
- BLOCK_COEF Ship/model block coefficient
- HULL_COND Condition of ship/model hull (e.g. paint type)
- NUMBER_OF_RUDDERS Number of rudders on ship/model
- NUMBER_OF_SHAFTS Number of shafts on ship/model
- Z Number of blades per propeller
- PROP_DIAM [m] Propeller diameter
- P/D Propeller blade pitch/blade diameter
- COMMENTS Comments about test or data quality
- REFS Source of data

3.2 Quality of data

This database was created through searching for any publicly available reports that contained vessel manoeuvring in ice data, and then entering all available data into the database. In some cases a report was not written as a scientific documentation of a “manoeuvring in ice” study, but rather was written to give a semi-technical report outlining the manoeuvring capability of a particular vessel. Thus, much crucial data is missing from some reports.

In addition, some data came from the “Ship in Ice Performance Database Version 1.0” (Transportation Development Centre, 1995). Some of these data were compared with their respective references and found to be in error. A comprehensive quality check of

this data was not possible within the time frame of this study due to the difficulty in obtaining the references in time for data verification, and hence errors are possible.

Aside from the above, other sources of error were present and are listed below.

3.2.1 Possible full-/model-scale test procedural errors

Some full- and model-scale tests were carried out with the rudder “hard over”. This can lead to rudder stall during tests in thick ice where the vessel is in near bollard condition (Peirce and Peirce, 1987).

3.2.2 Errors or missing reported data

Sometimes R/L was published, but no specification of whether the given L was L_{WL} , L_{pp} (L_{bp}), or L_{OA} . This is significant because R is a “data entry” in the database and R/L is a “calculated entry”; therefore some R values were calculated (before they were entered into the database) by multiplying the published R/L value with the available L given in the report - whether it was L_{pp} or L_{WL} .

Generally water densities were not reported. Displacements of model scale vessels were assumed to be for fresh water unless done in the IOT ice tank, in which case, the water density $\rho=1002.5 \text{ kg/m}^3$. Densities for other ice tanks (e.g. HSVA) are unknown. Displacements of full-scale ships are assumed to be salt water ($\rho= 1025 \text{ kg/m}^3$) unless data is known to be obtained from fresh water (i.e. great lakes).

Missing turning circle direction and propeller rotation direction made determining the bias due to differential shaft thrust and centre prop rotation impossible.

3.2.3 Human error

Human error is always a possibility, but extra care and effort have been given to minimize the possibility of data entry error. Data was checked and rechecked after initial data entry.

In addition to random human error, some of the data was extracted from photocopies of dot matrix printouts on which some of the numbers were hard to make out.

4.0 ESTABLISHED FUNCTIONAL RELATIONSHIPS

A study of the results reported by most investigators shows that the following functional relationships are prevalent to “manoeuvring in ice” data analysis.

The R/L ratio is the most recognized measure of icebreaker manoeuvring performance. This may be due to its success and popularity as a measure of open water performance; however, during an open water performance test, conditions do not usually change. Ice manoeuvring tests do not share this stability. They are not as reliable because a vessel’s manoeuvring performance in ice depends on other factors such as ice thickness, ice strength, and ice density, etc. These ice conditions may also change over the course of each test. Despite these, R/L is the standard measure of ice manoeuvring performance. Efforts are made during tests in ice to identify the properties of the ice over the entire test area.

Generally, a lower value of R/L is better than a higher value. The R/L ratio has been shown by various authors since the 1970’s to be dependent upon these following parameters:

h_i (ice thickness): R/L generally *increases* with increasing ice thickness.

C_f (coefficient of hull-ice interface friction): C_f is affected by use of a bubbler, water sprayer, and/or paint: R/L generally *increases* with increasing C_f .

δ (Rudder angle): R/L generally *decreases* with increasing rudder angle except in the event of rudder stall.

V (Ships Speed): R/L trends are *variable* with ship speed because increased ship speed increases flow over the rudder, which increases the vessels turning moment. However increasing ship speed also increases lateral resistance to the vessel’s turning motion.

L/B (waterline length-to-waterline breadth ratio): R/L generally *increases* with increasing length-to-breadth ratio.

L/T (waterline length-to-draught ratio): R/L generally *decreases* with increasing length-to-draught ratio.

L/L_{pmb} (waterline length-to-length of parallel mid-body ratio): Not generally reported anymore because vessels either have substantial side flare, or reamers to create mid-body taper. R/L generally *decreases* with increasing length-to-length of parallel mid-body ratio.

σ_f (ice flexural strength): R/L generally *increases* with increasing ice flexural strength.

Heel angle: R/L usually *decreases* with increasing heel angle, but only to a point. Also, whether the heel should be to port or to starboard for a port turn depends on the individual vessels geometry.

Side flare angle: R/L usually *decreases* with increasing flare angle.

Reamer width: R/L usually *decreases* with increasing reamer width.

Shaft/rudder arrangement: R/L is lower for vessels with a 3/1, 2/2, or 1/1 propeller shaft/rudder arrangement because the rudder(s) is directly in the propeller(s) race(s), which increases propeller lift. The 2/1 propeller shaft/rudder arrangements have higher R/L values.

Bow shape: R/L is lower for bows like the “spoon” bow or the “Thyssen-Wass” bow and higher for bows like the “conventional” bow or other “wedge” shaped bows.

5.0 DATABASE ANALYSIS

This database provides essential manoeuvring performance data for analyzing the individual icebreakers, for comparing icebreakers to each other, or for examining how icebreaker design would affect manoeuvring performance. These are only three examples of the functionality of this database; others are left to the users' needs.

Some of the functional relationships given in Section 4.0 will be used in this section to provide example analyses of the above three uses for the database.

5.1 Performance Analysis of Individual Icebreaker

An individual icebreaker's manoeuvring capabilities can be analyzed based on various test parameters, e.g. variation in ice thickness or ship speed. Comparison of manoeuvring performance, i.e. non-dimensional steady turning radius (R/L), as a function of any of these parameters allows examination of the icebreakers strengths and weaknesses. The analysis may also show the quality of the tests by identifying possible outliers.

The *USCGC Polar Star* (Figure 14) (Menon et al., 1986) was used for this example of individual icebreaker analysis. The *Polar Star* is a polar icebreaker that was commissioned in 1976. She is over 107 m between perpendiculars with a waterline L/B ratio of about 4.4 and a block coefficient of 0.62. She has three screws and one rudder and can break 1.8 m thick ice at 3 knots. The *Polar Star* is also equipped with a heeling system.

The plots shown below are the results of tests done in January of 1985 in level ice at McMurdo Sound, Antarctica. Turning circle tests were completed at various speeds, ice thicknesses, rudder angles, variable shaft thrust, and turning circle direction.

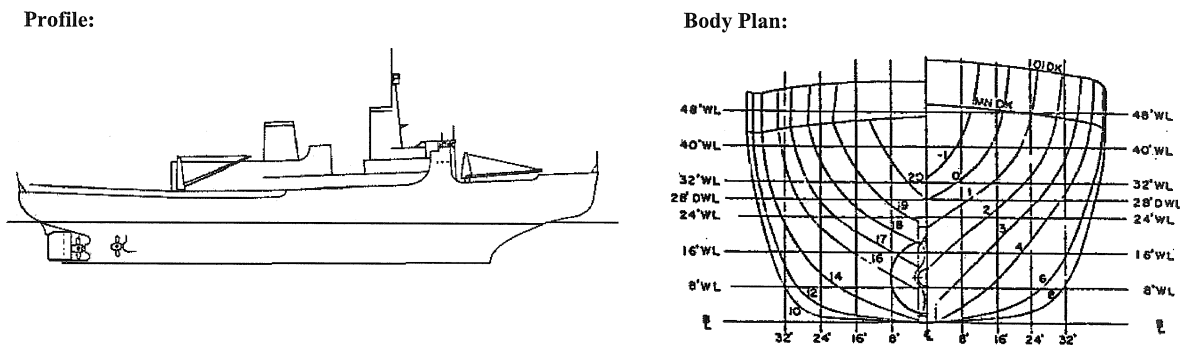

Figure 14: *USCGC Polar Star.*

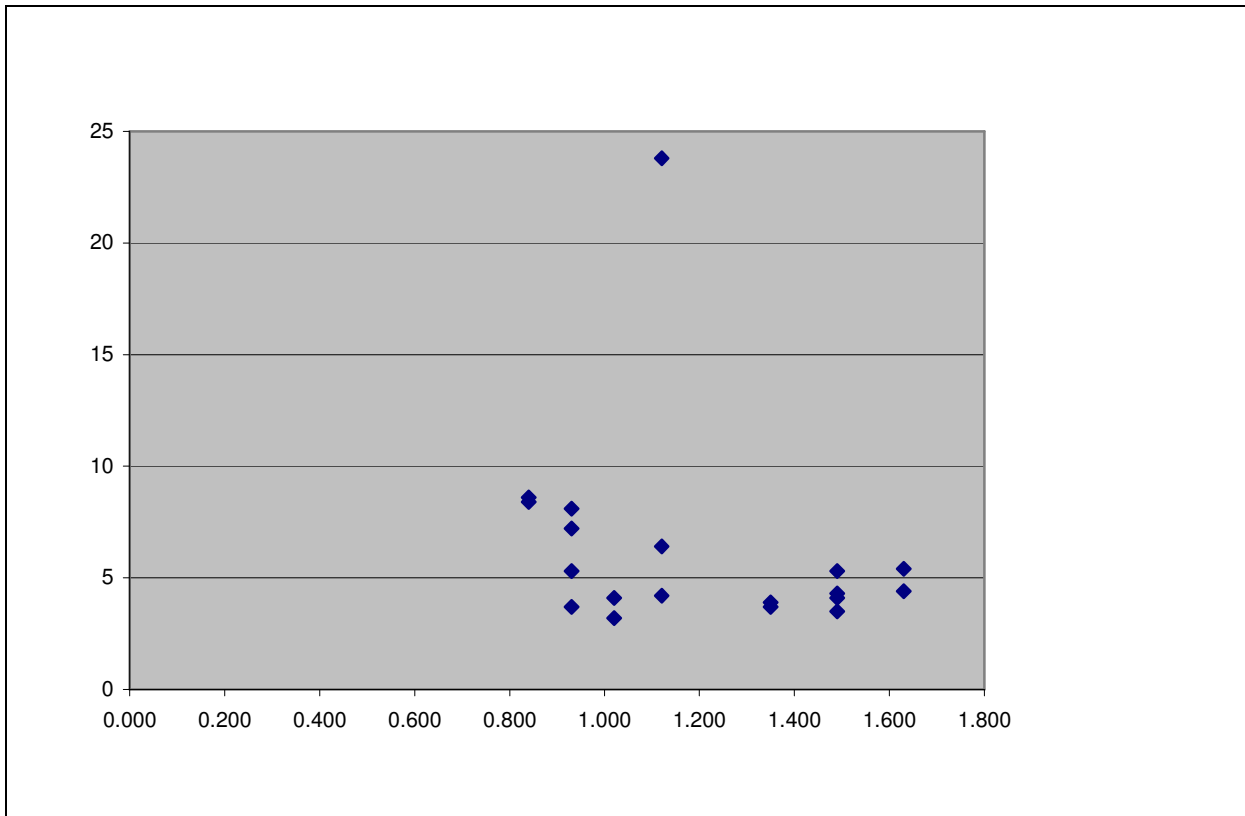

Figure 15: R/L vs. Ice Thickness (h_i).

Figure 15 shows the *Polar Star's* manoeuvring performance (R/L) for each test versus the ice thickness (h_i) in which each test was performed. Contrary to the common findings, the trend in the graph seems to show that R/L decreases (i.e. manoeuvring improves) as ice thickness increases. It is not correct to draw this conclusion based on this graph alone however, and inspection of R/L versus other test variables will show that these tests were not performed under the same circumstances (i.e. the speed, rudder angle, shaft thrust distribution, etc... was different for each test).

One could also notice the outlying data point of $R/L \approx 24$ at about $h_i = 1.15$. This data point doesn't seem to fit with the data. Whether it is an anomaly or a valid test can be explained by observing the graphs of R/L versus some other variables.

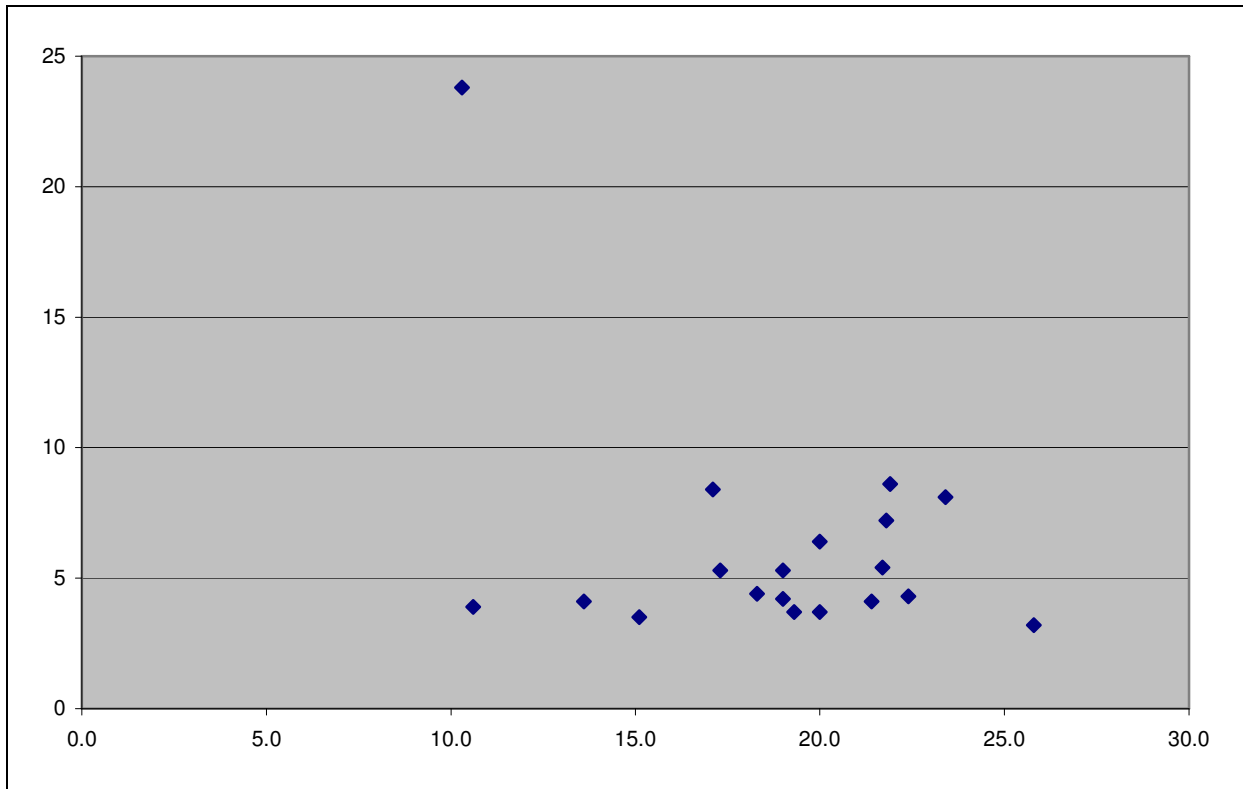

Figure 16: R/L vs. Rudder Angle (δ).

Figure 16 is a plot of R/L as a function of rudder angle. We can see from this figure that the rudder angle varied from test to test. This also calls into question on the apparent trend of a decreasing R/L with an increasing ice thickness.

This plot also shows that the outlier (R/L \approx 24) was obtained at the lowest rudder angle tested, i.e., 10°. This lends some credibility to the test run (as opposed to it being an anomaly) because we know from other tests that R/L tends to increase for lower rudder angles (i.e. the vessel will not turn as quickly at low rudder angles).

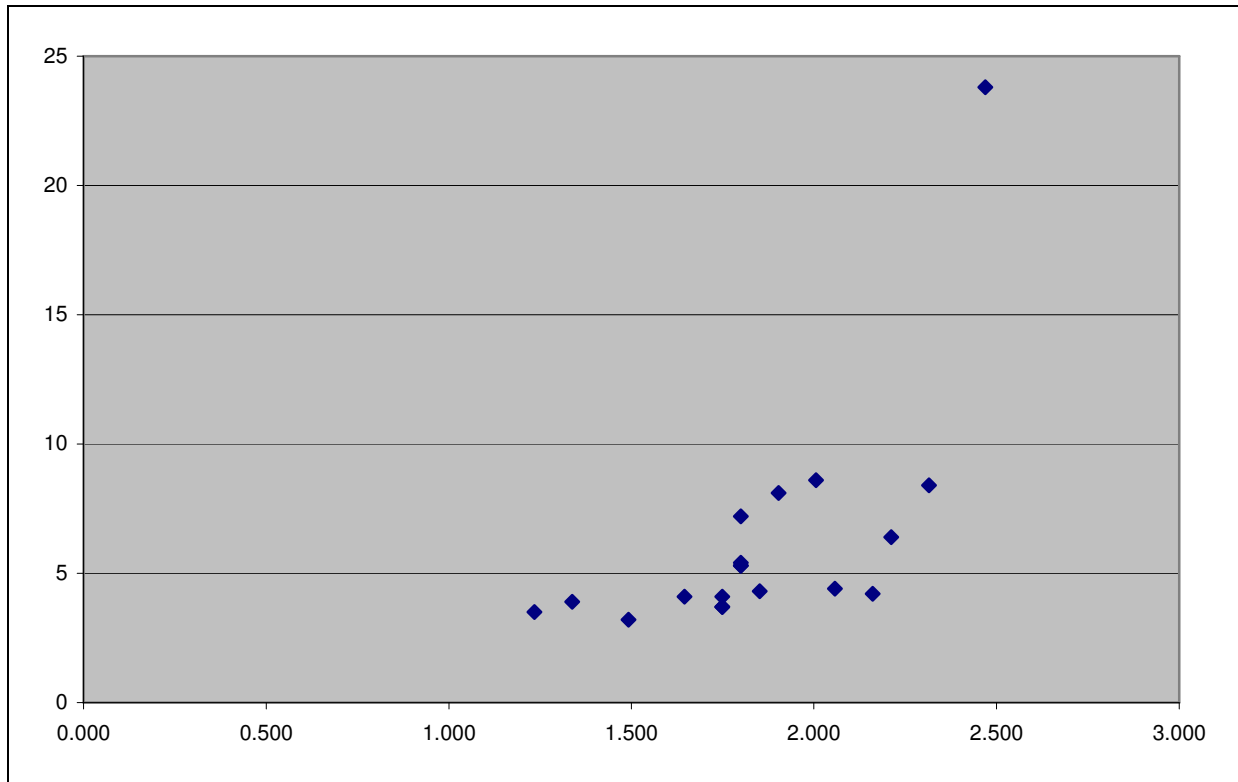

Figure 17: R/L vs. Ship Speed (V).

Figure 17 is a plot of R/L versus ship speed. This figure shows that these tests were performed at different ship speeds, which further called into question the validity of the apparent decreasing trend of R/L vs. h_i .

Inspection of the outlier (R/L \approx 24) shows that the test was performed at the highest ship speed. High speed coupled with low rudder angle further suggests that this point may be a credible test result.

In order to extract the true functional relationship between the R/L and h_i from the Polar Star data, the value of R/L was plotted against h_i in Figure 18 with the two narrow bands of rudder angle corresponding to 18 and 22 degrees respectively and a speed between 1.5 to 2 m/s.

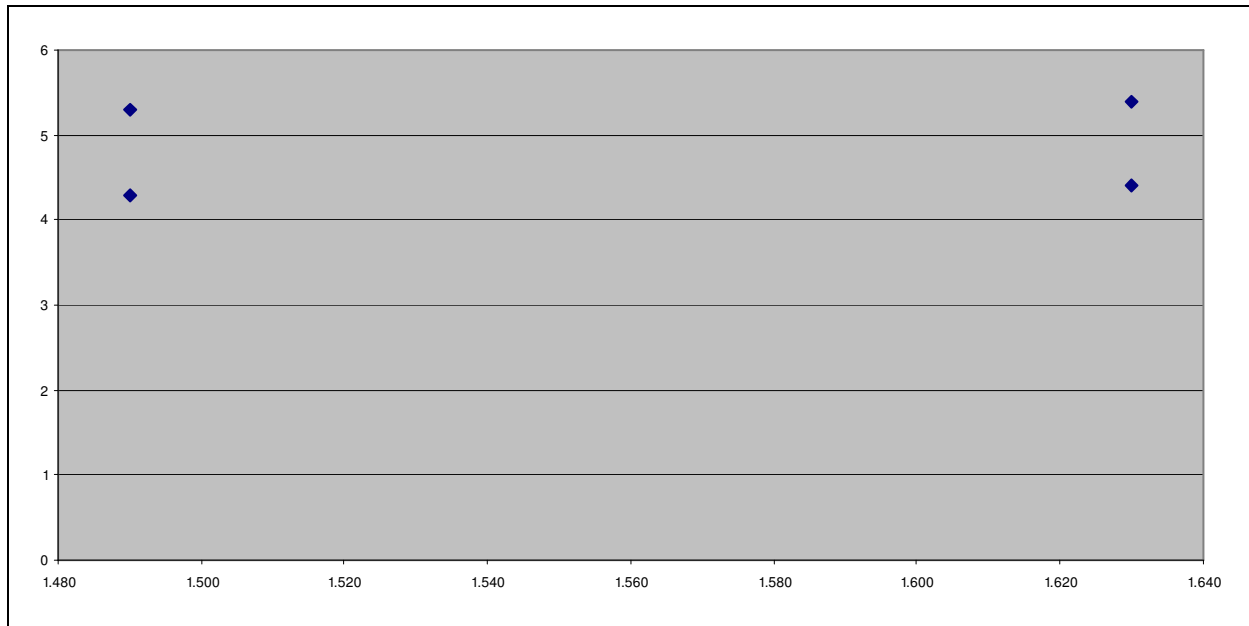

Figure 18: R/L vs. Ice Thickness (h_i) for Two Narrow Bands.

The above example has illustrated the danger of making pre-mature conclusion based on superficial analysis of the data. Cautions should be taken to isolate the effect of each influencing factor on the manoeuvring performance of a vessel during analysis.

Further examination of other relationships such as R/L vs. Snow Cover or R/L vs. Centre Shaft Thrust (as a percentage of total thrust) would shed light on the influences of those factors.

5.2 Performance Analysis Among Different Icebreakers

In order to compare performance of one icebreaker against another, each icebreaker has to be tested under similar conditions, i.e., the ice properties and ship speed would need to be similar. With this in mind, tests with similar condition were selected for analysis from various test series involving different icebreakers.

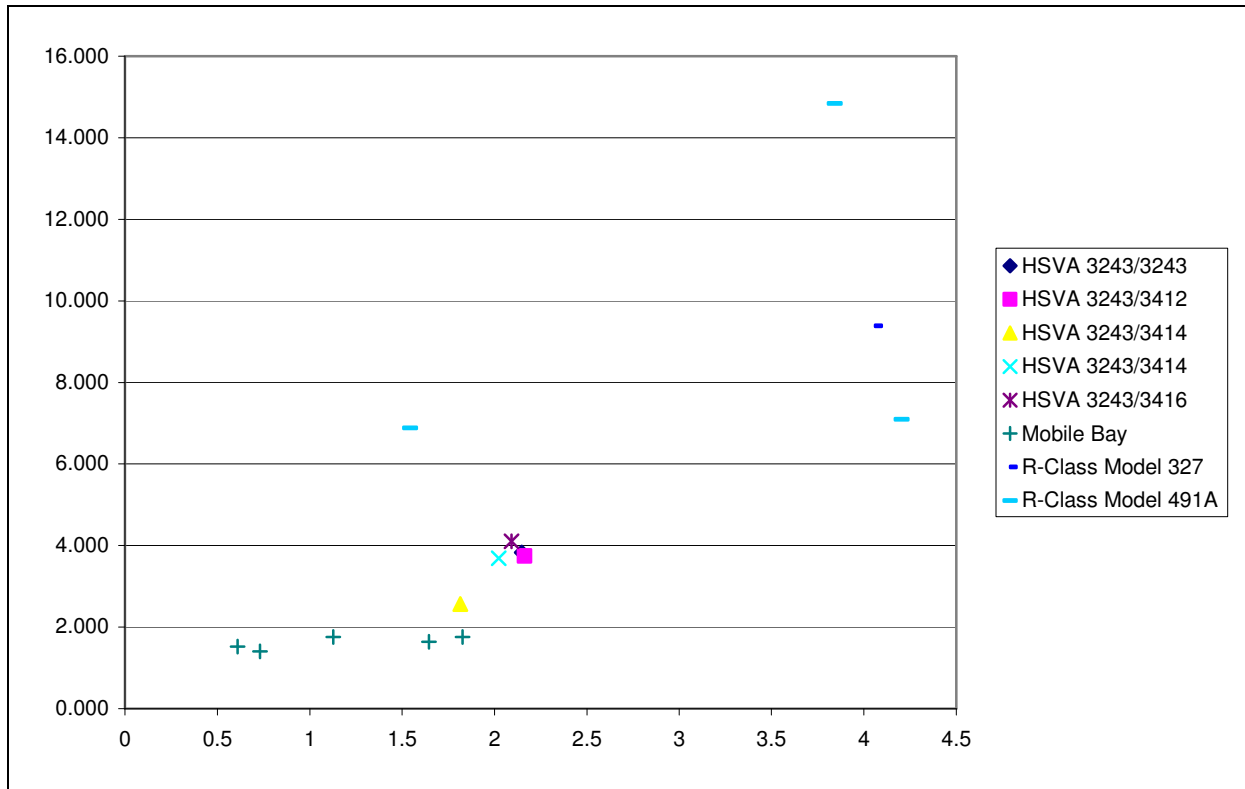

Figure 19: R/L vs. Scaled Model Speed (V) for Similar Test Conditions.

Figure 19 shows a plot of manoeuvring performance versus scaled model speed for similar test conditions. It would not be correct to compare icebreaker model test series using their model-scale speeds because each series of tests uses a different model-scale. Therefore it is necessary to scale the speeds to full-scale before comparison; hence “normalized model speed”. The data for *R-Class Model 327* was extracted from Menon et al. (1991), HSVA models data from Hellmann et al. (1992), *R-Class 491A* model data from Molyneux et al. (1998), and *Mobile Bay* model data from Kannari et al. (1987). The common test condition is $0.040 \leq h_i \leq 0.050$ [m] and $27.5 \leq \delta \leq 30$ [deg].

From the graph we can see that the *Mobile Bay* has the best manoeuvring performance compared with the other icebreakers tested in its operating range, i.e., *R-Class Model 327* and *HSVA 3242/3414*. The *Mobile Bay* has $L/B = 3.8$, $C_B = 0.43$, and has one propeller shaft and one rudder. The *R-Class Model 327* has $L/B = 4.8$, $C_B = 0.64$, and has two propeller shafts and one rudder. The *HSVA 3242/3414* has $L/B = 4.2$, $C_B =$ [not given] and has two propeller shafts and two rudders.

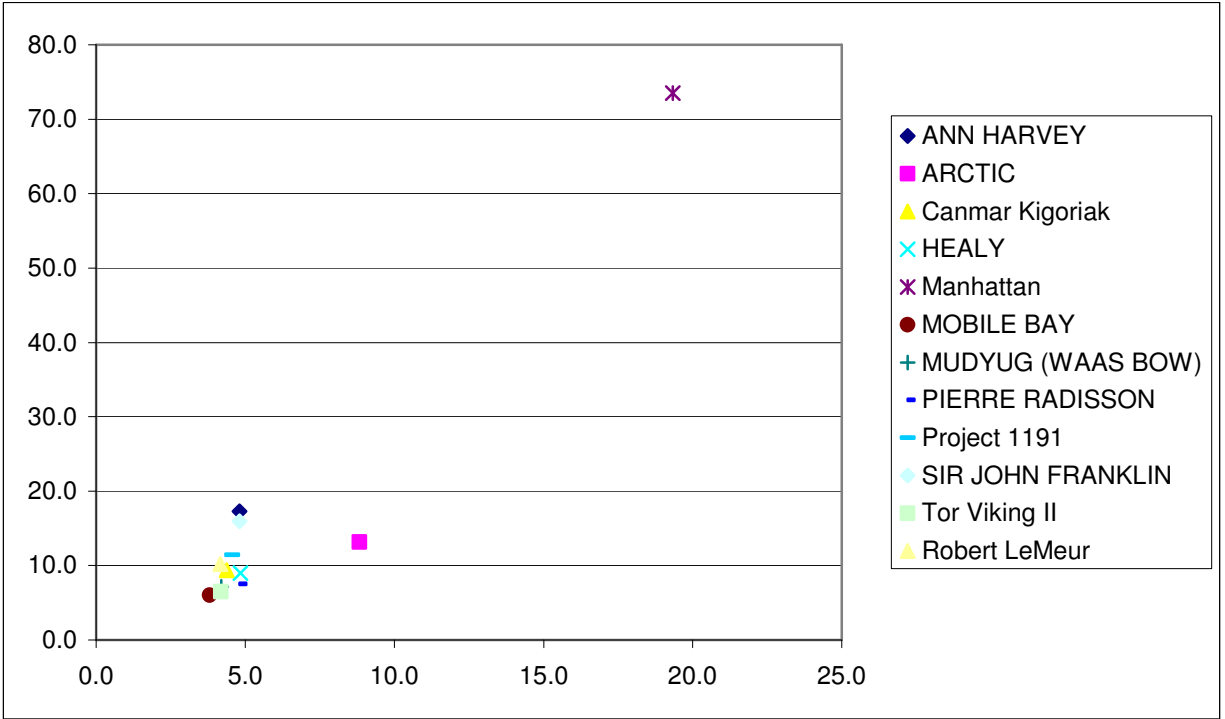

Figure 20: R/L vs. L/B for Similar Test Conditions.

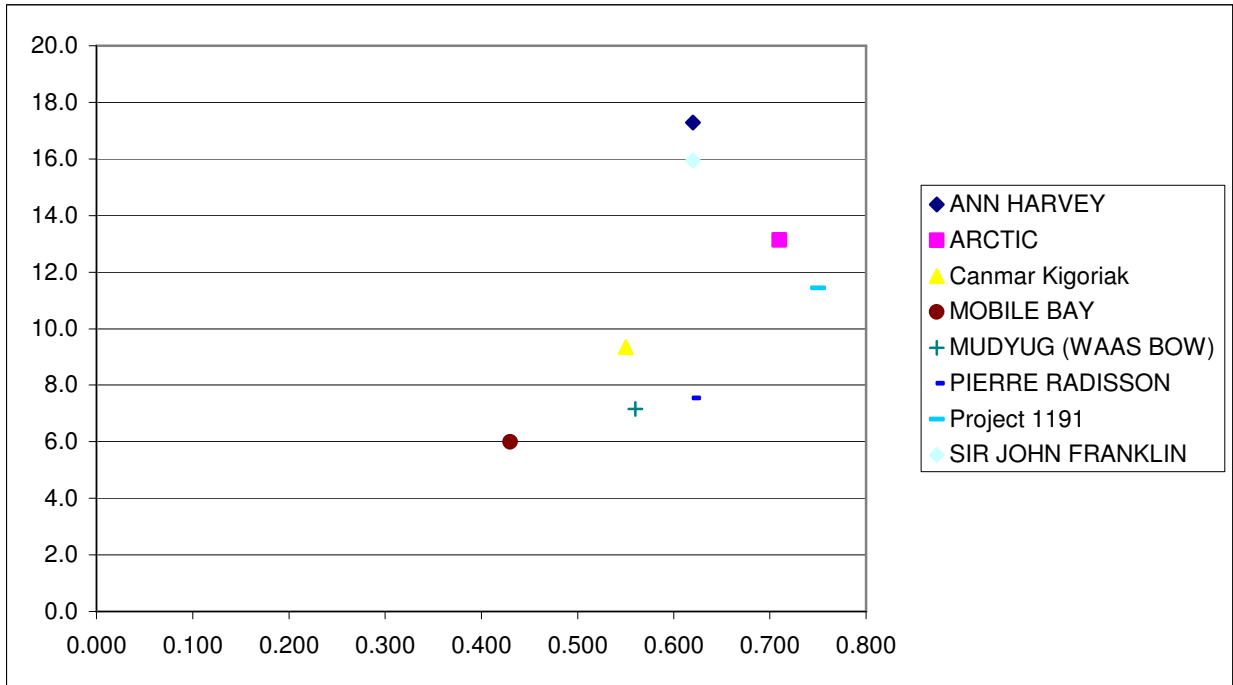

Figure 21: R/L vs. C_B for Similar Test Conditions.

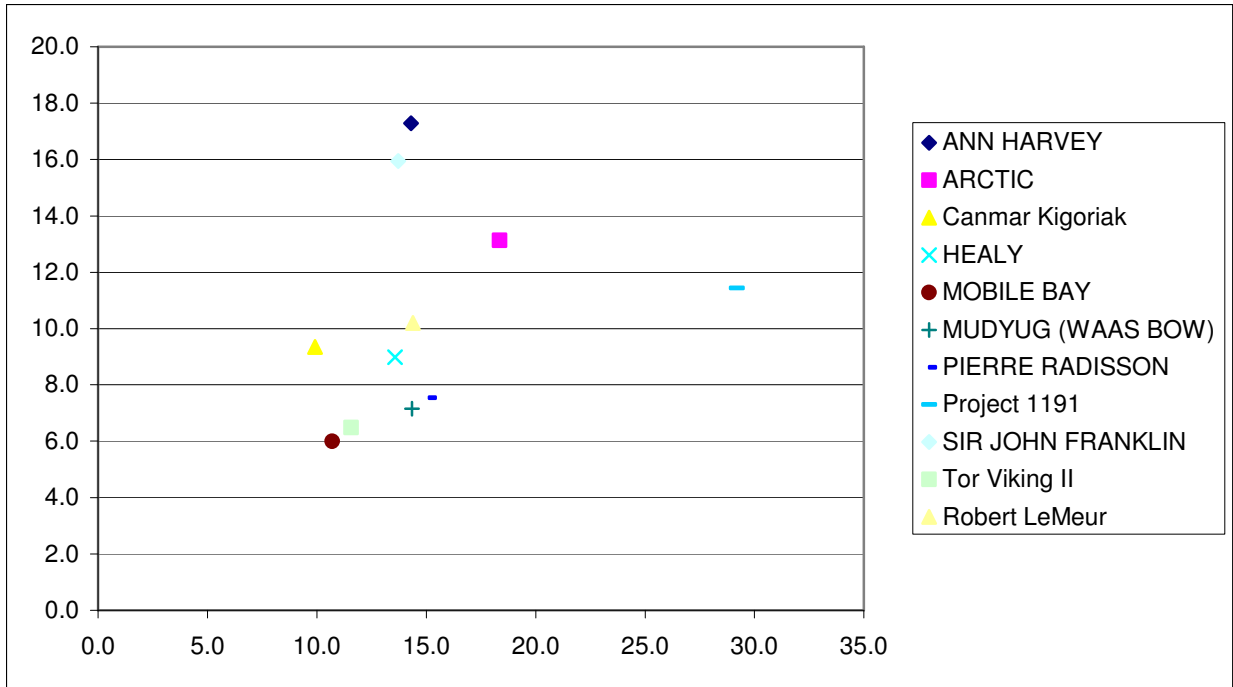

Figure 22: R/L vs. L/D for Similar Test Conditions.

Figure 20, Figure 21, and Figure 22 show the influences of L/B , C_B , and L/D on the value of R/L for icebreakers of various classes and designs. Much of the data used in these figures was extracted from the “Ship in Ice Performance Database Version 1.0”. This data referenced very well and for that reason, the references were not able to be cited here. The common test condition used for these plots was the maximum continuous icebreaking conditions for each vessel, and such is different for each vessel.

These figures show that the *Mobile Bay* has the best performance (with the lowest R/L ratio) among the icebreakers analyzed; however, it should be noted that the icebreakers compared in these three figures are not in the same class and most of these vessels have different missions. The *Mobile Bay* is a Great Lakes icebreaking tug while the *M.V. Arctic* is a polar cargo ship. Further analysis of data in details among different classes and ship forms may give a better assessment of the individual icebreaker.

5.3 Analysis of Influencing Factors on R/L

Over the past forty years, advances in icebreaker design have been made through identifying the variables that affect manoeuvring performance. As mentioned several times in this report, the influencing factors: h_i , V , δ , σ_i , C_B , L/B , L/D , shaft/rudder arrangement, and others, all have a major effect on manoeuvring performance (R/L).

In this section brief analysis is given to illustrate the influences of these variables on R/L . Although data for each icebreaker was collected from tests performed under similar test conditions, test conditions were not the same for different icebreakers (i.e. tests for icebreaker “A” may have taken place at 2.0 m/s in variable ice thickness at rudder “hard over” while tests for icebreaker “B” may have taken place at 3.4 m/s in variable ice

conditions with rudder at 10°). Hence, these analyses only give a bird's eye view of the influences of various factors on ship manoeuvring performance.

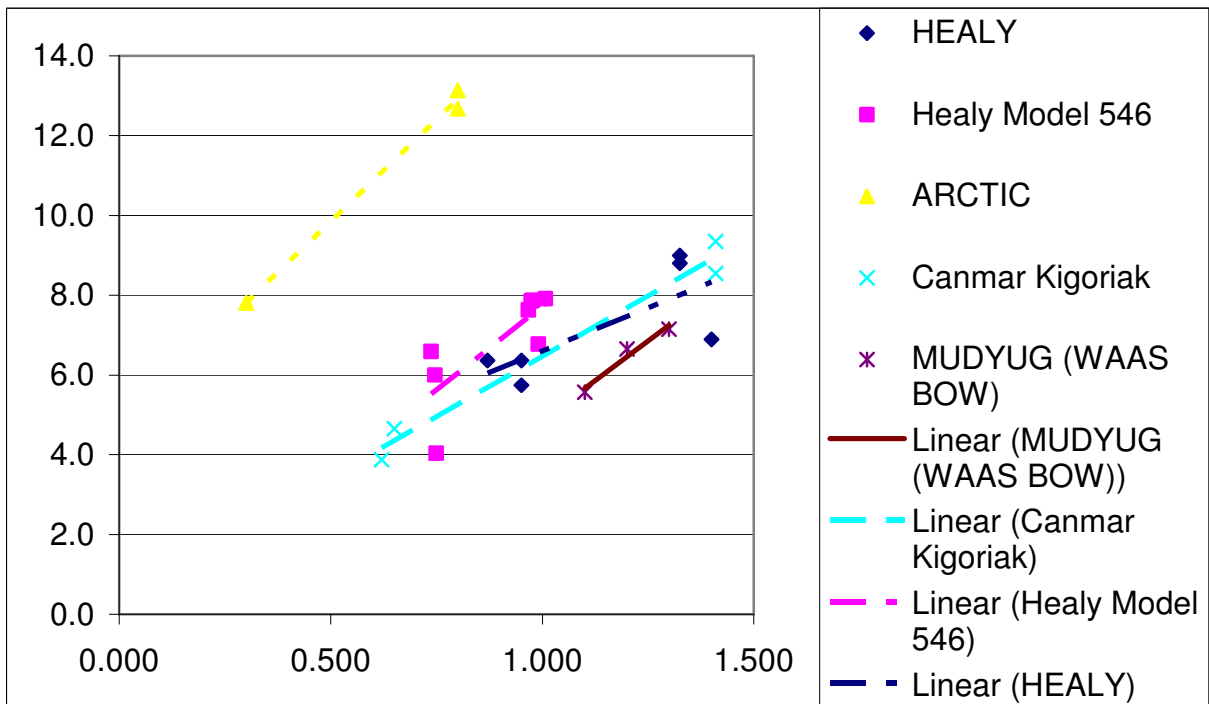

Figure 23: R/L vs. h_i Trends.

Figure 23 is a plot of R/L versus ice thickness. It shows clearly that R/L increases with ice thickness. This means that the manoeuvring performance of any vessel generally decreases as ice thickness increases.

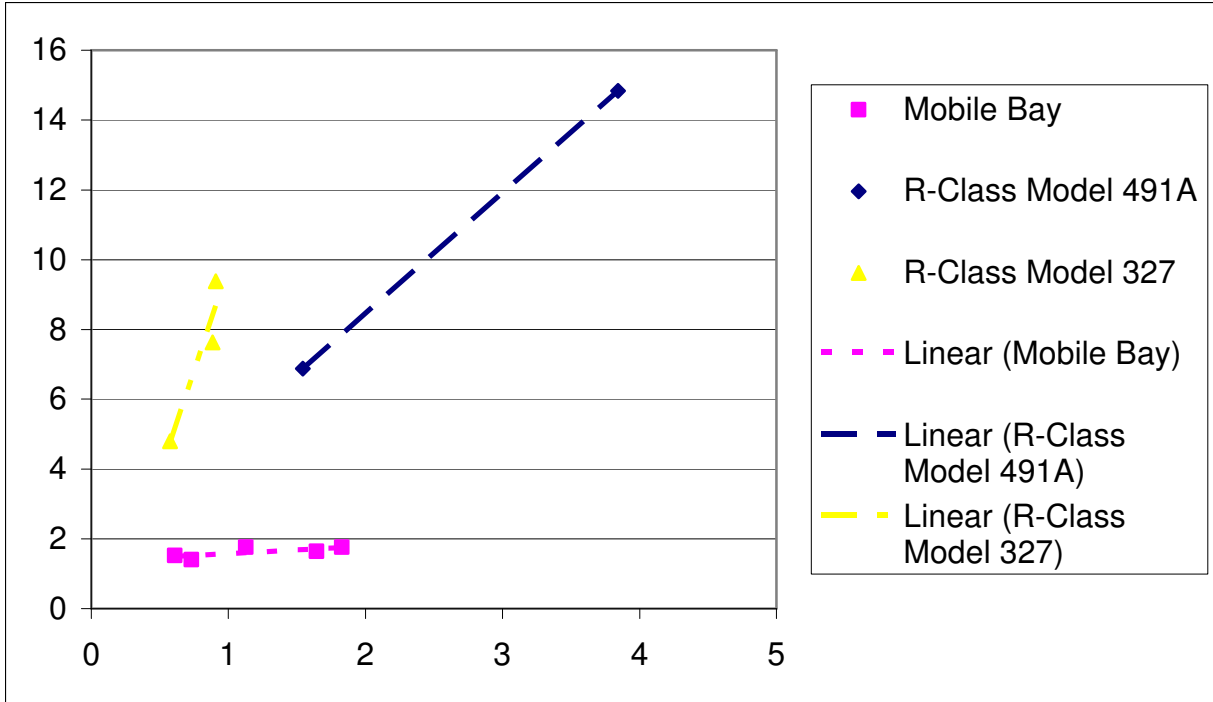

Figure 24: R/L vs. Ship Speed Trends.

Figure 24 is a plot of R/L versus ship speed. It shows that generally, *R/L* increases with ship speed. This means that manoeuvring performance decreases as ship speed increases. It should be pointed out that these results are highly dependent on flow over the ships rudder. For vessels with one rudder and two shafts manoeuvring performance can increase with ship speed because of increased flow over the rudder.

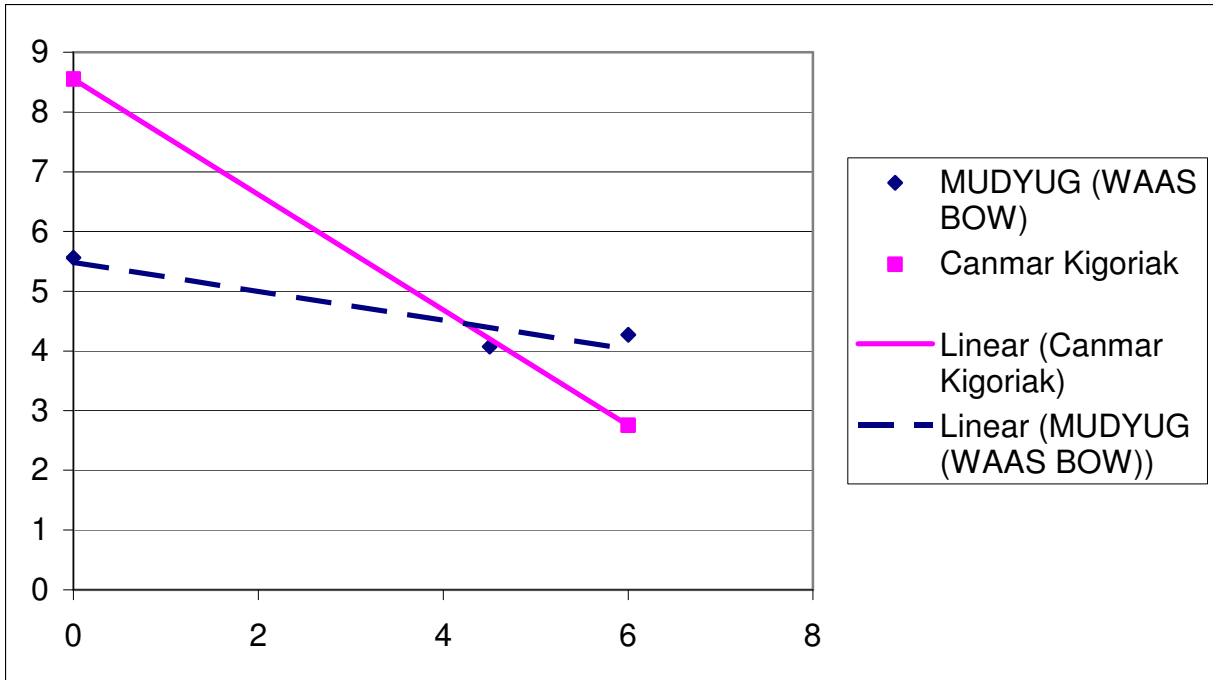

Figure 25: R/L vs. Heel Angle Trends.

Figure 25 is a plot of R/L versus heel angle. It shows that R/L decreases with increased heel angle.

6.0 SUMMARY AND RECOMMENDATIONS

A literature review of over 120 reports was completed. The state-of-the-art of icebreaking vessels along with all available “manoeuvring in ice” test data was identified. The post-1995 test data was taken directly from published reports and the pre-1995 test data was taken (unverified) from the database “Ship in Ice Performance Database Version 1.0”. All data was consolidated into a new Microsoft Excel database called “Manoeuvring in Ice.xls”, which is ready for use. Example analyses were provided.

Much care was taken to ensure accurate data reproduction during the creation of this database; however, it is recommended that the data from the “Ship in Ice Performance Database” be verified as much as feasible as time constraint did not allow thorough verification of the accuracy of the extracted data against their sources.

7.0 REFERENCES

General Review

Browne, R.P., Carter, J.E., and Kimberly, P.C., 1984. Design, Construction and First Season's Operation of M.V. Kalvik and M.V. Terry Fox, Offshore Technology Conference, 16th, Houston, Texas, May 7-9. Proceedings. Vol.1, p.495-505. United States.

Cumming, D., and Pallard, R., 2002. Description of Manoeuvring Experiments Carried Out on Halifax Class Frigate Model IMD538, NRC/IOT Report TR-2002-22, Institute for Ocean Technology, National Research Council of Canada, St. John's, NL.

Edwards R.Y., Major R.A., and J.K. Kim, 1976. Influence of Major Characteristics of Icebreaker Hull on Their Powering Requirements and Maneuverability in Ice, SNAME Transactions, Vol. 84: pp364~407.

Ettema, R., Sharifi, M.B., Georgakakos, K.P., and F. Stern, 1991. Chaos in Continuous-Mode Icebreaking, Cold Regions Science and Technology, Vol. 19, pp. 131-144, Netherlands.

Freitas, A., 1981. Experimental Investigation of Novel Icebreaker Concept, Ship Technology and Research (STAR) Symposium, 6th, Ottawa, Ontario, June 17-19, 1981. Proceedings, p.369-380. New York, N.Y., Society of Naval Architects and Marine Engineers. United States.

Freitas, A., 1982. Results of Spring 1981 and 1982 Full Scale Trials with the Modified "Max Waldeck", Thyssen Nordseewerke GmbH, Emden F.R. of Germany. Presented at the Meeting of the SNAME Arctic Section, Calgary, November 24th.

Freitas, A., 1983. Marine Operations in the Arctic Based on the Tyssen-Waas Concept, 7th International Conference on Port and Ocean Engineering Under Arctic Conditions (POAC), Helsinki, Finland, Vol. 1, pp. 505-515.

Hellmann, J.-H., and J. Schwarz, 1983. Performance Tests of Icebreaker Max Waldeck in Model and Full Scale, International Conference on Port and Ocean Engineering under Arctic conditions, 7th, Helsinki, Finland, April 5-9. Proceedings, p.534-549. Espoo, Finland.

Hellmann, J.-H., and P. Valanto, 1992. Aftbody Development for Icebreaking Vessels with Regard to Propulsion, Maneuvering and Astern Performance, HSVA, Report #: E 228/92.

Hoffmann, K., 1998. Ship Maneuvering in Ice with the Planar Motion Mechanism R-Class Testing, NRC/IMD Report LM-1998-19.

ITTC Committee, 1990. Maneuverability Model Tests in Ice, 19th ITTC Proceedings v. 1, Madrid, Spain, 16-22 September.

Johansson, B., and G. Liljeström, 1989. Oden – Icebreaker Technology for the Year 2000, Society of Naval Architects and Marine Engineers, Transactions, Vol.97, p.53-83. United States.

Juurmaa, K., Mattsson, T., and G. Wilkman, 2001. The Development of the New Double Acting Ships for Ice Operation, Kvaerner Masa-Yards Arctic Technology, Ottawa, Canada, 16th International Conference on Port and Ocean Engineering Under Arctic Conditions (POAC), August 12-17, pp. 719-726.

Kannari, P., and D.H. Humphries, 1987. Maneuvering Performance in Ice of the United States Coast Guard 140 Foot Icebreaker, International Conference on Port and Ocean Engineering under Arctic Conditions (POAC), 9th, Fairbanks, Alaska, Aug. 17-22. Proceedings, Vol.1. Edited by W.M. Sackinger and M.O. Jeffries pp.557-574. University of Alaska, Geophysical Institute. United States.

Keinonen, A., and P. Lohi, 2000. Azimuth and Multi Purpose Icebreaker Technology for Arctic and non-Arctic Offshore, Proceedings 10th International Offshore and Polar Engineering Conference, Seattle, USA, May 28 – June 2. Vol. 1 pp722-728.

Kendrick, A.M., Dadachanji N., and B. Quart, 1984. M.V. ARCTIC – Maneuvering Performance in Ice Final Report, Transport Canada. TP 5684E.

Leiviskä, T., and K. Riska, 2000. Full Scale Trials of Tor Viking II 10-13 March 2000, Helsinki University of Technology, Ship Laboratory, Arctic Offshore Research Centre, Rpt D-62, Otaniemi, 50 p+app.

Lindstrom, C-A., 1990. Numerical Simulation of Ship Maneuvering Motion in Level Ice, International Conference on Development and Commercial Utilization of Technologies in Polar Regions, Copenhagen, Denmark, Aug. 14-16. Proceedings. Polartech '90, p.198-208. Hörsholm, Denmark, Danish Hydraulic Institute. Denmark.

Marineering Limited, 1997. The Development and Commissioning of a Large Amplitude Planar Motion Mechanism for Maneuvering of Ships in Ice and Open Water – Volume 1: Main Report, NRC/IMD Report CR-1997-05 Vol. 1 of 3, Institute for Ocean Technology, National Research Council of Canada, St. John's, NL.

Menon, B.C., Edgecombe, M., Tue-fee, K., and I. Glen, 1986. Maneuvering tests in ice aboard USCGC Polar Star in Antarctica 1985, ARCTEC CANADA LIMITED, FR1723C-2.

Menon, B.C., Glen I.F., Steel M., and K. Hardiman, 1991. Investigation of Ship Maneuverability in Ice-Phase I. Transport Canada, TP 10922E.

Molyneux, W.D., Simões Ré, A., Spencer, D., Hardiman, K., and F.N. Winsor, 1988. Polar 8 Design Phase; Results of Experiments in Open Water and Ice with Design D (Volume I), NRC/IMD Report TR-HYD-28, Institute for Ocean Technology, National Research Council of Canada, St. John's, NL.

Narita, S., and M. Yamaguchi, 1981. Some Experimental Study on Hull Forces for the New Japanese Antarctic Research Ship, Ship Technology and Research (STAR) Symposium, 6th, Ottawa, Ontario, June 17-19. Proceedings, p.253-271. New York, N.Y., Society of Naval Architects and Marine Engineers. United States.

Newbury, S., 1991. Modelling Techniques for Icebreaking Hull Forms, NRC/IMD Report LM-1991-10, Institute for Ocean Technology, National Research Council of Canada, St. John's, NL.

Peirce, T.H., and J.C. Peirce, 1987. A Survey of the Potential for Improving the Maneuverability of Ice-transiting Vessels, Transport Canada, Report: TP 8434.

Riska, K., Jalonen, R., Veitch, B., Nortala-Hoikkanen, A., and G. Wilkman, 1994. Assessment of Ice Model Testing Techniques, International Conference on Ships and Marine Structure in Cold Regions, 5th, Calgary, Alberta, Canada, March. Proceedings. ICETECH '94, p.F1-F22. Society of Naval Architects and Marine Engineers. Canada.

Shi, Y., 2002. Model Test Data Analysis of Ship Maneuverability in Ice, Thesis submitted to the School of Graduate Studies, Memorial University of Newfoundland, St. John's, Canada, May.

Spencer, D., 1997. Comparison of Open Water and Ice Performance for R-Class and Thyssen Bow Forms, Marineering Limited, NRC/IMD Report CR-1997-02, Institute for Ocean Technology, National Research Council of Canada, St. John's, NL.

Stubbs, J.T., Tue-Fee, K.K., and A.J. Keinonen, 1983. Advances in Arctic Icebreaker Design, Proceedings of the Symposium on Science and Arctic Hydrocarbon Exploration, The Beaufort Experience, Whitehorse, Yukon, Canada, September. Pp 67-80. Dome Petroleum Limited.

Transportation Development Centre, 1995. Ship/Ice Interaction Database Version 1.0 User's Manual, Transportation Development Centre, May.

Tue-Fee, K.K., 1985. Full Scale Maneuvering Tests in Level Ice of "Canmar Kigoriak" and "Robert LeMeur", presented at Arctic Section, SNAME, January 16. Canadian Marine Drilling Limited.

Varges, G., 1987. Advances in Icebreaker Design - The Conversion of the Soviet Polar Icebreaker Mudyug into a Thyssen / Waas Ship, Thyssen Nordseewerke GmbH. 6th WEMT Symposium: Sommer Tagung, Travemünde, 2. bis 5. Juni 1987. ppA47-A71. West European Conference on Marine Technology.

Waclawek, P., Molyneux, D., and J. Woodward, 1998. Ship Maneuvring using the PMM: A Numerical Analysis, NRC/IMD Report LM-1998-18, Institute for Ocean Technology, National Research Council of Canada, St. John's, NL.

Williams, F.M., Spencer, D., Parsons, B., Hackett, P., Gagnon, B., Everard, J., and S. Butt, 1991. Full-Scale Ice Breaker Trials CCGS Sir John Franklin Indian Arm/Little Burnt Bay 1991, NRC/IMD Report TR-1991-03, Institute for Ocean Technology, National Research Council of Canada, St. John's, NL.

Yamaguchi, H., Suzuki, Y., Uemura, O., and H. Kato, 1997. Influence of Bow Shape on Iceberaking Resistance in Low Speed Range, 16th, and International Conference on Port and Ocean Engineering Under Arctic Conditions (POAC), 14th, Yokohama, Japan, Apr. 13-17. Proceedings. Vol.4. Edited by H. Yamaguchi, K. Izumiyama, D.S. Sodhi, W.A. Nixon, and H. Kitagawa, p.51-61. New York, American Society of Mechanical Engineers. United States.

Theoretical

Edwards R.Y., Major R.A., and J.K. Kim, 1976. Influence of Major Characteristics of Icebreaker Hull on Their Powering Requirements and Maneuverability in Ice, SNAME Transactions, Vol. 84: pp364~407.

Keinonen, A., and P. Lohi, 2000. Azimuth and Multi Purpose Icebreaker Technology for Arctic and non-Arctic Offshore, Proceedings 10th International Offshore and Polar Engineering Conference, Seattle, USA, May 28 – June 2. Vol. 1 pp722-728.

Kendrick, A.M., Dadachanji N., and B. Quart 1984. M.V. ARCTIC – Maneuvering Performance in Ice Final Report, Transport Canada. TP 5684E.

Marineering Limited, 1997. The Development and Commissioning of a Large Amplitude Planar Motion Mechanism for Maneuvering of Ships in Ice and Open Water – Volume 1: Main Report, NRC/IMD Report CR-1997-05 Vol. 1 of 3, Institute for Ocean Technology, National Research Council of Canada, St. John's, NL.

Menon, B.C., Edgecombe, M., Tue-fee, K., and I. Glen, 1986. Maneuvering tests in ice aboard USCGC Polar Star in Antarctica 1985, ARCTEC CANADA LIMITED, FR1723C-2.

Menon, B.C., Glen I.F., Steel M., and K. Hardiman, 1991. Investigation of Ship Maneuverability in Ice-Phase I. Transport Canada, TP 10922E.

Newbury, S., 1991. Modelling Techniques for Icebreaking Hull Forms, NRC/IMD Report LM-1991-10, Institute for Ocean Technology, National Research Council of Canada, St. John's, NL.

Peirce, T.H., and J.C. Peirce, 1987. A Survey of the Potential for Improving the Maneuverability of Ice-transiting Vessels, Transport Canada, Report: TP 8434.

Riska, K., Jalonen, R., Veitch, B., Nortala-Hoikkanen, A., and G. Wilkman, 1994. Assessment of Ice Model Testing Techniques, International Conference on Ships and Marine Structure in Cold Regions, 5th, Calgary, Alberta, Canada, March. Proceedings. ICETECH '94, p.F1-F22. Society of Naval Architects and Marine Engineers. Canada.

Shi, Y., 2002. Model Test Data Analysis of Ship Maneuverability in Ice, Thesis submitted to the School of Graduate Studies, Memorial University of Newfoundland, St. John's, Canada, May.

Tue-Fee, K.K., 1985. Full Scale Maneuvering Tests in Level Ice of "Canmar Kigoriak" and "Robert LeMeur", presented at Arctic Section, SNAME, January 16. Canadian Marine Drilling Limited.

Full-Scale Sea Trial

Edwards R.Y., Major R.A., and J.K. Kim, 1976. Influence of Major Characteristics of Icebreaker Hull on Their Powering Requirements and Maneuverability in Ice, SNAME Transactions, Vol. 84: pp364~407.

Freitas, A., 1982. Results of Spring 1981 and 1982 Full scale Trials with the Modified "Max Waldeck", Thyssen Nordseewerke GmbH, Emden F.R. of Germany. Presented at Arctic Section SNAME, Calgary, November.

Kannari, P., and D.H. Humphries, 1987. Maneuvering Performance in Ice of the United States Coast Guard 140 Foot Icebreaker, International Conference on Port and Ocean Engineering under Arctic Conditions (POAC), 9th, Fairbanks, Alaska, Aug. 17-22. Proceedings, Vol.1. Edited by W.M. Sackinger and M.O. Jeffries pp.557-574. University of Alaska, Geophysical Institute. United States.

Menon, B.C., Edgecombe, M., Tue-fee, K., and I. Glen, 1986. Maneuvering tests in ice aboard USCGC Polar Star in Antarctica 1985, ARCTEC CANADA LIMITED, FR1723C-2.

Mookhoek, A.D., Voelker, R.P., and F.W. DeBord, 1981. Summary of Selected Technical Results from Manhattan Arctic Marine Projects, Ship Technology and Research (STAR) Symposium, 6th, Ottawa, Ontario, June 17-19, 1981. Proceedings, p.21-33. New York, N.Y., Society of Naval Architects and Marine Engineers. United States.

Riska K., Leiviskä, T., Nyman, T., Fransson, L., Lehtonen, J., et al, 2001. Ice Performance of the Swedish Multi-Purpose Icebreaking Tor Viking II, Proceedings – 16th International Conference on Port and Ocean Engineering under Arctic Conditions (POAC), Vol.16(Vol. 2), p.849-865, Ottawa, ON, Canada, Aug. 12-17, edited by R.

Frederking, I. Kubat and G.W. Timco. International Conference on Port and Ocean Engineering under Arctic Conditions, International.

Sodhi, D.S., Griggs, D.B., and W.B. Tucker, 2001. Healy Ice Trials: Performance Tests in Ice, Proceedings – 16th International Conference on Port and Ocean Engineering under Arctic Conditions, Vol.16(Vol. 2), p.893-907, Ottawa, ON, Canada, Aug. 12-17, edited by R. Frederking, I. Kubat and G.W. Timco. International Conference on Port and Ocean Engineering under Arctic Conditions, International.

Tronin, V.A., et al., 1986. Investigation of Ice Navigation, Properties of Icebreakers, and Organization of icebreaking Operations in River Basins, IAHR Symposium on Ice, 8th, Iowa City, Aug. 18-22. Proceedings, Vol.2, p.87-99. United States.

Tue-Fee, K.K., 1985. Full Scale Maneuvering Tests in Level Ice of “Canmar Kigoriak” and “Robert LeMeur”, presented at Arctic Section, SNAME, January 16. Canadian Marine Drilling Limited.

Williams, F.M., Spencer, D., Parsons, B., Hackett, P., Gagnon, B., Everard, J., and S. Butt, 1991. Full-Scale Ice Breaker Trials CCGS Sir John Franklin Indian Arm/Little Burnt Bay 1991, NRC/IMD Report TR-1991-03, Institute for Ocean Technology, National Research Council of Canada, St. John’s, NL.

Williams, F.M., Spencer, D., Mathews, S.T., and I. Bayly, 1992. Full Scale Trials in Level Ice with Canadian R-Class Icebreaker, SNAME Transactions, Vol. 100, pp293~313.

Free Model Test

Hellmann, J.-H., and P. Valanto, 1992. Aftbody Development for Icebreaking Vessels with Regard to Propulsion, Maneuvering and Astern Performance, HSVA, Report #: E 228/92.

Kannari, P., and D.H. Humphries, 1987. Maneuvering Performance in Ice of the United States Coast Guard 140 Foot Icebreaker, International Conference on Port and Ocean Engineering under Arctic Conditions (POAC), 9th, Fairbanks, Alaska, Aug. 17-22. Proceedings, Vol.1. Edited by W.M. Sackinger and M.O. Jeffries pp.557-574. University of Alaska, Geophysical Institute. United States.

Menon, B.C., Glen I.F., Steel M., and K. Hardiman, 1991. Investigation of Ship Maneuverability in Ice-Phase I. Transport Canada, TP 10922E.

Molyneux, W.D., Simões Ré, A., Spencer, D., Hardiman, K., and F.N. Winsor, 1988. Polar 8 Design Phase; Results of Experiments in Open Water and Ice with Design D (Volume I), NRC/IMD Report TR-HYD-28, Institute for Ocean Technology, National Research Council of Canada, St. John’s, NL.

Molyneux, W.D., Williams, F.M., and K. Hoffmann, 1998. Evaluation of Performance Limitations for Ships Navigating to and from Voisey's Bay Part 5; Maneuvring Experiments in Level, Pack and Rubble Ice, NRC/IMD Report TR-1998-07, Institute for Ocean Technology, National Research Council of Canada, St. John's, NL.

Molyneux, D., and H-S. Kim, 2004. Icebreaking Tanker for Samsung Heavy Industries: Manoeuvring Experiments in Ice on a Single Screw Tanker, NRC/IOTReport TR-2004-11, Institute for Ocean Technology, National Research Council of Canada, St. John's, NL.

Molyneux, D., and H-S. Kim, 2004. Icebreaking Tanker for Samsung Heavy Industries: Resistance and Propulsion Experiments in Ice on a Single Screw Tanker, NRC/IOT Report TR-2004-09, Institute for Ocean Technology, National Research Council of Canada, St. John's, NL.

PMM Model Test

Marineering Limited, 1997. The Development and Commissioning of a Large Amplitude Planar Motion Mechanism for Maneuvering of Ships in Ice and Open Water – Volume 1: Main Report, NRC/IMD Report CR-1997-05 Vol. 1 of 3, Institute for Ocean Technology, National Research Council of Canada, St. John's, NL.

Shi, Y., 2002. Model Test Data Analysis of Ship Maneuverability in Ice, Thesis submitted to the School of Graduate Studies, Memorial University of Newfoundland, St. John's, Canada.

Spencer, D., 1997. Comparison of Open Water and Ice Performance for R-Class and Thyssen Bow Forms, Marineering Limited, NRC/IMD Report CR-1997-02, Institute for Ocean Technology, National Research Council of Canada, St. John's, NL.

8.0 BIBLIOGRAPHY

Abkowitz, M.A., and G. Liu, 1988. Measurement of Ship Resistance, Powering, and Maneuvering Coefficients from Simple Trials during a Regular Voyage, Transactions of SNAME, Vol96, pp97~128.

Alexander, I.B., Sergey V.K., and U.B. Shankar, 1997. Application of an Empirical-statistical Model of Ship Motion in Ice to New Types of Icebreakers and Ships, Proceedings of the 16th International Conference on Offshore Mechanics and Arctic Engineering/14th International Conference on Port and Ocean Engineering under Arctic Conditions (Joint OMAE/POAC Conference), Vol. IV, pp43~49.

Albery, Pullerits Dickson and Associates. M.V. ARCTIC Ice Transiting Performance, Continuous Mode, Dickson and Associates in association with Coldstream Maritime Inc., Gastops Ltd. and D.F. Dickins Associates Ltd. Prepared for Transportation Development Centre. TP 5170 E.

Anon., 1985. Japanese/Finnish Icebreaking VLCC Design, Canadian Shipping and Marine Engineering, November, Vol. 57, No. 62, pp. 18-19.

Anon., 1986. Tervi - Finland's. Largest Tankers move into Neste for Archipelago Service, article from The Motor Ship, May, Vol. 67, No. 790, pp. 27-31.

Anon., 1986. Finland Maintains Impetus in Icebreaking, The Motor Ship, November, Vol. 67, No. 796, pp. 56-58.

Arctec Canada Limited, 1987. Evaluation of the Performance of a Modern Commercial Icebreaker : Volume 1 – The Report on the 1986 Trials of M.V. Kalvik: Main Report, Volume 2 – Appendices, TP 8269E, February, for Canadian Coast Guard (Northern), by Arctec Canada Limited.

Baker, D.N., 1984. Redesign of the M.V. Arctic Bow-Design and Model Testing, Report No. TP5456E, Melville Shipping Ltd. prepared for Transportation Development Centre, May.

Bassetf, N.L., Kline, R.G. and R.H. Miller, 1983. Design and Operation of a Highly Maneuverable Great Lakes Self-Loader, Marine Technology, Vol. 20, No. 2, pp 150-158.

Bjerkelund, C., 1986. Level Ice Physical Properties in support of the M.V. ARCTIC Performance Trials in Baffin Bay and Admiralty Inlet, May-June 1986, Norland Science and Engineering Ltd., TDC Report 6671.

Brigham, L.W., and R.P. Voelker, 1985. Ice Navigation Studies in the Alaskan Arctic Using Polar Class Icebreakers, Oceans '85 Conference, San Diego, CA, Nov. 12-14, 1985. Proceedings. Vol.1, p.441-447. United States.

Browne, R.P., Carter, J.E., and P.C. Kimberly, 1984. Design, Construction and First Season's Operation of M.V. Kalvik and M.V. Terry Fox, Offshore Technology Conference, 16th, Houston, Texas, May 7-9. Proceedings. Vol.1, p.495-505. United States.

Churcher, A., Kolomojcev, A. and G. Hubbard, 1984. Design of the Icebreaking Supply Ship Robert Lemeur, Marine Technology, Vol. 21, No. 2, April. pp.134-146. United States.

Cumming, D., and R. Pallard, 2002. Description of Manoeuvring Experiments Carried Out on Halifax Class Frigate Model IMD538, NRC/IMD Report TR-2002-22, Institute for Ocean Technology, National Research Council of Canada, St. John's, NL.

Cumming, D., 1996. Results of Flow Visualization, Powering, Wake Survey and Manoeuvrability Experiments on an Ice Class Ferry, NRC/IMD Report TR-1996-15, Institute for Ocean Technology, National Research Council of Canada, St. John's, NL.

Dome Petroleum Limited, 1982. Final Report on Full Scale Measurements of the Ice Impact Loads and Response of the Kigoriak August and October, 1981, Dome Petroleum Limited, Report #32-7.

Dome Petroleum, 1982. 1979/80 Full Scale Tests of the Icebreaker Kigoriak, Dome Petroleum, September.

Dome Petroleum, 1983. Summary Ice Data Compilation and Analysis, Kigoriak Full scale Tests, Winter 1979-1980, Report 21, Dome Petroleum, December.

Edwards, R.Y., Lewis J.W., Wheaton J.W., and J. Coburn, 1972. Full-Scale and Mode Tests of a Great Lakes Icebreaker, Society of Naval Architects and Marine Engineers. Transactions, Vol.80, p.170-207. United States.

Edwards R.Y., Major R.A., and J.K. Kim, 1976. Influence of Major Characteristics of Icebreaker Hull on Their Powering Requirements and Maneuverability in Ice, SNAME Transactions, Vol. 84: pp364~407.

Edwards, R.Y., Dunne, M.A., Comfort, G., Bulat, V., and B. Johnson, 1981. Results of Full Scale Trials in Ice of CCGS Pierre Radisson, Ship Technology and Research (STAR) Symposium, 6th, Ottawa, Ontario, June 17-19, 1981. Proceedings, p.291-310. New York, N.Y., Society of Naval Architects and Marine Engineers. United States.

Fenco Newfoundland Limited, 1981. Lake Melville/Offshore Labrador Winter Navigation Study 1979-80, Fenco Newfoundland Limited, in association with Nordco Limited, for Department of Regional Economic Expansion, Newfoundland and Labrador Department of Development.

Freitas, A., 1983. Marine Operations in the Arctic Based on the Tyssen-Waas Concept, 7th International Conference on Port and Ocean Engineering Under Arctic Conditions (POAC), Helsinki, Finland, Vol. 1, pp. 505-515.

Freitas, A., 1982. New Aspects of Shipping in Ice Emerging from the Expedition with the Max Waldeck, International Conference on Marine Research, Ship Technology and Ocean Engineering, Hamburg, Sep. 29-30. Proceedings. Intermaritec '82, p.385-400. Hamburg. Germany, West.

Freitas, A., 1982. Results of Spring 1981 and 1982 Full scale Trials with the Modified "Max Waldeck", Thyssen Nordseewerke GmbH, Emden F.R. of Germany. Presented at Arctic Section SNAME, Calgary, November.

Freitas, A., 1981. Experimental Investigation of Novel Icebreaker Concept, Ship Technology and Research (STAR) Symposium, 6th, Ottawa, Ontario, June 17-19, 1981. Proceedings, p.369-380. New York, N.Y., Society of Naval Architects and Marine Engineers. United States.

German, J.G. and N. Dadachanji, 1975. Hull Forms of Arctic Bulk Cargo Transportation, presented at SNAME May.

Glen, I, Goosens, L., Voelker, R.P., Kotras, T., and F. Geisel, 1985. Polar Class Antarctic 1984 Level Ice Resistance Tests, Arctec Canada Limited for TDC, TP 7183 E. March.

Gray, W.O., and R. Maybourn, 1981. Manhattan's Arctic Venture -A Semi technical History, Ship Technology and Research (STAR) Symposium, 6th, Ottawa, Ontario, June 17-19. Proceedings, p.1-20. New York, N.Y., Society of Naval Architects and Marine Engineers. United States.

Gulf Canada Resources Inc., 1985. M.V. Terry Fox Level Ice Performance Trials, January, Gulf Canada Resources Inc. Frontier Development Division, May.

Gulick, R.W., Vance, G.P., Hill, J.R. and D. Bagnell, 1981. Polar Class Icebreaker Ice Deflecting Hull Appendages – A Joint Research Effort, Ship Technology and Research (STAR) Symposium, 6th, Ottawa, Ontario, June 17-19. Proceedings, p.203-215. New York, N.Y., Society of Naval Architects and Marine Engineers. United States.

Haruzo, E., and F. DeBord, 1981. Maneuvering Characteristics of Great lakes Ships in critical channels, Davidson Laboratory Report no. 2198. Davidson Laboratory, Maritime Administration, Office of Commercial Development. Hoboken, New Jersey, United States.

Hellmann, J.-H., 1982. Model and Full Scale Tests in Ice with the Icebreaker “Max Waldeck”, International Conference on Port and Ocean Engineering under Arctic conditions (POAC), 7th, Helsinki, Finland, April 5-9. Proceedings, p.534-549. Espoo, Finland, Valtion Teknillinen Tutkimuskeskus. Finland.

Hellmann, J.-H., and J. Schwarz, 1983. Performance Tests of Icebreaker Max Waldeck in Model and Full Scale, International Conference on Port and Ocean Engineering under Arctic conditions, 7th, Helsinki, Finland, April 5-9. Proceedings, p.534-549. Espoo, Finland.

Hellmann, J.-H., and P. Valanto, 1992. Aftbody Development for Icebreaking Vessels with Regard to Propulsion, Maneuvering and Astern Performance, HSVA, Report #: E 228/92.

Hoffmann, K., 1998. Ship Maneuvering in Ice With the Planar Motion Mechanism R-Class Testing, NRC/IMD Report LM-1998-19, Institute for Ocean Technology, National Research Council of Canada, St. John's, NL.

HSVA (Hamburgische Schiffbau-Versuchsanstalt), 1986. Erste Eisbrechtechnische Expedition mit F S Polarstern: Volumes 1-3, Hamburgische Schiffbau Versuchsanstalt GmbH and Germanischer Lloyd, April.

ITTC Committee, 1990. Maneuverability Model Tests in Ice, 19th ITTC Proceedings V. 1, Madrid, Spain, September 16-22.

Jansson, J., Saarikangas, M, and T. Heideman, 1986. Operational Experience with the New-Type Baltic Icebreaker OTSO, International Offshore and Navigation Conference and Exhibition, Helsinki, Oct. 27-30, 1986. POLARTECH '86. Symposium 71, p.1039-1060. Espoo, Valtion Teknillinen Tutkimuskeskus. Finland.

Johansson, B., and G. Liljeström, 1989. Oden – Icebreaker Technology for the Year 2000, Society of Naval Architects and Marine Engineers, Transactions, Vol.97, p.53-83. United States.

Johansson, B.M., Saarikangas, J.M. et al, 1975. 16.2 MW Baltic Icebreakers, Ice Tech Symposium, Montreal, Canada, April 9-11. Proceedings, 14p. New York, Society of Naval Architects and Marine Engineers. United States.

Jones, S. J., Spencer, D., and R. McKenna, 1994. Icebreaking Performance from Model Scale Tests, International Conference on Ships and Marine Structure in Cold Regions, 5th, Calgary, Alberta, Canada, March. Proceedings. ICETECH '94, p.H1-H19. Society of Naval Architects and Marine Engineers. Canada.

Juurmaa, K., Mattsson, T., and G. Wilkman, 2001. The Development of the New Double Acting Ships for Ice Operation, Kvaerner Masa-Yards Arctic Technology, Ottawa, Canada, 16th International Conference on Port and Ocean Engineering Under Arctic Conditions (POAC), August 12-17, pp. 719-726.

Kamarainen, J., 1994. On the Speed Dependence of the Ice Submerging Resistance in Level Ice, International Offshore and Polar Engineering Conference, 4th, Osaka, Japan, Apr. 10-15. Proceedings. Vol.2. Edited by J.S. Chung, K. Karal, and W. Koterayama, p.578-583. Golden, CO, International Society of Offshore and Polar Engineers (ISOPE). United States.

Kanerva, M. and B. Lonnberg, 1985. Icebreaking Cargo Ships, Royal Institution of Naval Architects, Transactions, Vol.127, p.309-327. United Kingdom.

Kannari, P., and D.H. Humphries, 1987. Maneuvering Performance in Ice of the United States Coast Guard 140 Foot Icebreaker, International Conference on Port and Ocean Engineering under Arctic Conditions (POAC), 9th, Fairbanks, Alaska, Aug. 17-22. Proceedings, Vol.1. Edited by W.M. Sackinger and M.O. Jeffries pp.557-574. University of Alaska, Geophysical Institute. United States.

Kano, M., et al., 1983. Study of Icebreaking Performance of Large Arctic Tanker, International Conference on Port and Ocean Engineering under Arctic conditions, 7th, Helsinki, Finland, April 5-9. Proceedings, p.634-643. Espoo, Finland, Valtion teknillinen tutkimuskeskus. Finland.

Keinonen, A., and P. Lohi, 2000. Azimuth and Multi Purpose Icebreaker Technology for Arctic and non-Arctic Offshore, Proceedings 10th International Offshore and Polar Engineering Conference, Seattle, USA, May 28 – June 2. Vol. 1 pp722-728.

Keinonen, A.J., and J. Duff, 1983. Canmar Kigoriak - Demonstration of Arctic Capability, International Conference on Port and Ocean Engineering under Arctic conditions, 7th, Helsinki, Finland, April 5-9. Proceedings, p.620-633. Espoo, Finland, Valtion Teknillinen Tutkimuskeskus. Finland.

Kendrick, A.M., Dadachanji N., and B. Quart, 1984. M.V. ARCTIC – Maneuvering Performance in Ice Final Report, Transport Canada. TP 5684E.

Kivimaa, S., 1993. Long Term Ice Load Measurements with an Ice Load Panel on Board the Cutter M.S. ULSKO, International Conference on Port and Ocean Engineering under Arctic Conditions, 12th, Hamburg, Aug. 17-20. Proceedings. POAC 93. Vol.1, p.338-347. Hamburg, Germany, Hamburg Ship Model Basin. Germany, West.

Kujala, P., 1996. Semi-empirical Evaluation of Long Term Ice Loads on a Ship Hull, Marine Structures. Vol. 9. pp849~871.

Lindroos, H., 1990. Operational Requirements and Experiences of Baltic Escort Icebreaker, International Conference on Icebreaking and Related Technologies, 4th, Calgary, Canada, March. Proceedings, p.G/1-G/10. Society of Naval Architects and Marine Engineers. Calgary, Canada.

Lindstrom, C-A., 1990. Numerical Simulation of Ship Maneuvering Motion in Level Ice, International Conference on Development and Commercial Utilization of Technologies in Polar Regions, Copenhagen, Denmark, Aug. 14-16. Proceedings. Polartech '90, p.198-208. Hörsholm, Denmark, Danish Hydraulic Institute. Denmark.

Lindstrom, C-A., 1990. Numerical Estimation of Ice Force Acting on Inclined Structures and Ships in Level Ice, Proceedings – 22nd Offshore Technology Conference, Vol.22, p.209-216, Houston, TX, May 7-10. United States.

Makinen, E. and R. Roos, 1977. Ice Navigation Capabilities of Lunni-Class Icebreaking Tankers, Paper presented at Eastern Canadian Section of SNAME, Montreal. Published by Helsinki : Wärtsilä.

Marineering Limited, 1997. The Development and Commissioning of a Large Amplitude Planar Motion Mechanism for Maneuvering of Ships in Ice and Open Water: Volume 1 - Main Report, NRC/IMD Report CR-1997-05 Vol. 1 of 3, Institute for Ocean Technology, National Research Council of Canada, St. John's, NL.

Matsuzawa, T., Yamaguchi, H., Kato, H., and T. Komura, 1999. Influence of Floe Rotation and Tangential Force Between Floes on Local Floe Behavior: Investigation by Discrete Element Model Computations, International Conference on Offshore Mechanics and Arctic Engineering, OMAE 99, 18th, St. John's, Newfoundland, July 11-16. pp1~7. New York, American Society of Mechanical Engineers. United States.

Melville Shipping Ltd., 1986. M.V. ARCTIC Ship Performance Testing, Spring 1986, Melville Shipping Ltd. for Canarctic Shipping Company Limited, July, Report #: TP 8135 E.

Menon, B.C., Glen I.F., Steel M., and K. Hardiman, 1991. Investigation of Ship Maneuverability in Ice-Phase I. Transport Canada, TP 10922E.

Menon, B.C., Edgecombe, M., Tue-fee, K., and I. Glen, 1986. Maneuvering tests in ice aboard USCGC Polar Star in Antarctica 1985, ARCTEC CANADA LIMITED, FR1723C-2.

Michailidis, M., and D.C. Murdey, 1981. Performance of CCGS Franklin in Lake Melville, Ship Technology and Research (STAR) Symposium, 6th, Ottawa, Ontario, June 17-19. Proceedings, p.311-322. New York, N.Y., Society of Naval Architects and Marine Engineers. United States.

Michailidis, M., 1981. M.V. ARCTIC Probe into Lake Melville Labrador, February/March, Ice Property Measurements, AVMRI(IMD), NRC/IMD Report LTR-SH-301, Institute for Ocean Technology, National Research Council of Canada, St. John's, NL.

Michailidis, M., 1980, CCGS Franklin Ice-breaking Probes 1 and 2 into Lake Melville, Labrador in January and March, NRC/IMD Report LTR-SH-283, Institute for Ocean Technology, National Research Council of Canada, St. John's, NL.

Molyneux, D., and H-S. Kim, 2004. Icebreaking Tanker for Samsung Heavy Industries: Manoeuvring Experiments in Ice on a Single Screw Tanker, NRC/IOT Report TR-2004-11, Institute for Ocean Technology, National Research Council of Canada, St. John's, NL.

Molyneux, D., and H-S. Kim, 2004. Icebreaking Tanker for Samsung Heavy Industries: Resistance and Propulsion Experiments in Ice on a Single Screw Tanker, NRC/IOT Report TR-2004-09, Institute for Ocean Technology, National Research Council of Canada, St. John's, NL.

Molyneux, W.D., Simões Ré, A., Spencer, D., Hardiman, K., and F.N. Winsor, 1988. Polar 8 Design Phase; Results of Experiments in Open Water and Ice with Design D (Volume I), NRC/IMD Report TR-HYD-28, Institute for Ocean Technology, National Research Council of Canada, St. John's, NL.

Molyneux, W.D, and F.M. Williams, 1999. Ship Powering Performance in Multiple Layers of Broken Ice, Proceeding of OMAE99, 18th International Conference on Offshore Mechanics and Arctic Engineering, July 11-16, St. Johns, Newfoundland, Canada, pp1~9.

Molyneux, W.D., Williams, F.M., and K. Hoffmann, 1998. Evaluation of Performance Limitations for Ships Navigating to and from Voisey's Bay Part 5; Maneuvring Experiments in Level, Pack and Rubble Ice, NRC/IMD Report TR-1998-07, Institute for Ocean Technology, National Research Council of Canada, St. John's, NL.

Mookhoek, A.D., Voelker, R.P., and F.W. DeBord, 1981. Summary of Selected Technical Results from Manhattan Arctic Marine Projects, Ship Technology and Research (STAR) Symposium, 6th, Ottawa, Ontario, June 17-19, 1981. Proceedings, p.21-33. New York, N.Y., Society of Naval Architects and Marine Engineers. United States.

Murday, D.C., 1980. Resistance and Propulsion Experiments with Model 327-1 and Propellers 66L and 66R, NRC Marine Dynamics and Ship Laboratory Report LTR-SH-269, March.

Narita, S., and M. Yamaguchi, 1981. Some Experimental Study on Hull Forces for the New Japanese Antarctic Research Ship, Ship Technology and Research (STAR)

Symposium, 6th, Ottawa, Ontario, June 17-19. Proceedings, p.253-271. New York, N.Y., Society of Naval Architects and Marine Engineers. United States.

Neth, V.W., and D.H. Boteler, 1981. M.V. Arctic Data Collection and Instrumentation, 1980 Season, Vols. 1 & 2, Fenco Consultants Ltd., Calgary, Canada, Report #: TP 3202.

Newbury, S., 1991. Modelling Techniques for Icebreaking Hull Forms, NRC/IMD Report LM-1991-10, Institute for Ocean Technology, National Research Council of Canada, St. John's, NL.

Newbury, S., and B-G Renborg, 1989. Maneuvering Tests in Ice with a Model of the New GVA Icebreaker ODEN – A Video Presentation, NRC/IMD Report LM-1989-21, Institute for Ocean Technology, National Research Council of Canada, St. John's, NL.

Noble, P., and G. Comfort, 1979. Ice Trials to Evaluate Low Friction Coating On C.C.G.S. Louis S. St-Laurent, Arctec Canada Limited for Canadian Coast Guard, Fleet System, FR357C-4, October 15.

Noble, P., Dunne, M., and R. Allan, 1977. Results of Full Scale Measurements aboard C.C.G.S. Louis S. St-Laurent during Early Arctic Probe 1977, Arctec Canada Limited for Canadian Coast Guard, Final Report No. 251C, November 21.

Perice, T.H., and J.C. Peirce, 1987. A Survey of the Potential for Improving the Maneuverability of Ice-transiting Vessels, Transport Canada, TP 8434.

Phillips, L., and P. Zahn, 1986. Towed Resistance Trials in ice of the USCGC Mobile Bay (WIGS 103): Volume 1 - Final Report, Volume 2 - Appendices, Arctec Canada Ltd. for Transportation Development Centre. IP 8487E, September.

Report of the Specialist Committee on 'Esso Osaka', 2002. Proceedings of 23rd International Towing Tank Conference, Venice, Italy, September 8-14, Vol. II, pp 573-609.

Riska, K., Leiviskä, T., Nyman, T., Fransson, L., Lehtonen, J., et al, 2001. Ice Performance of the Swedish Multi-Purpose Icebreaking Tor Viking II, Proceedings – 16th International Conference on Port and Ocean Engineering under Arctic Conditions (POAC), Vol.16(Vol. 2), p.849-865, Ottawa, ON, Canada, Aug. 12-17, edited by R. Frederking, I. Kubat and G.W. Timco. International Conference on Port and Ocean Engineering under Arctic Conditions, International.

Riska, K., Jalonen, R., Veitch, B., Nortala-Hoikkanen, A., and G. Wilkman, 1994. Assessment of Ice Model Testing Techniques, International Conference on Ships and Marine Structure in Cold Regions, 5th, Calgary, Alberta, Canada, March. Proceedings. ICETECH '94, p.F1-F22. Society of Naval Architects and Marine Engineers. Canada.

Shi, Y., 2002. Model Test Data Analysis of Ship Maneuverability in Ice, Thesis submitted to the School of Graduate Studies, Memorial University of Newfoundland, St. John's, Canada, May.

Sodhi, D.S., Griggs, D.B., and W.B. Tucker, 2001. Healy Ice Trials: Performance Tests in Ice, Proceedings – 16th International Conference on Port and Ocean Engineering under Arctic Conditions, Vol.16(Vol. 2), p.893-907, Ottawa, ON, Canada, Aug. 12-17, edited by R. Frederking, I. Kubat and G.W. Timco. International Conference on Port and Ocean Engineering under Arctic Conditions, International.

Spencer, D., 1997. Comparison of Open Water and Ice Performance for R-Class and Thyssen Bow Forms, Marineering Limited, NRC/IMD Report CR-1997-02, Institute for Ocean Technology, National Research Council of Canada, St. John's, NL.

Spencer, D., 1998. Manoeuvring Experiments Conducted on a Scale Model of the Articulated Tug/Barge, NRC/IMD, TR-1998-17, Institute for Ocean Technology, National Research Council of Canada, St. John's, NL.

Stubbs, J.T., Tue-Fee, K.K., and A.J. Keinonen, 1983. Advances in Arctic Icebreaker Design, Proceedings of the Symposium on Science and Arctic Hydrocarbon Exploration, The Beaufort Experience, Whitehorse, Yukon, Canada, September. Pp 67-80. Dome Petroleum Limited.

Takekuma, K., Kawaguchi, N. and I.F. Glen, 1984. Arctic Tanker Bow forms and Evaluation of Full Scale Propulsive Performance in Ice, International Conference on Icebreaking and Related Technologies, 3rd, Calgary, Canada, May. Proceedings, p.B/1-B/12. Society of Naval Architects and Marine Engineers. Calgary, Canada.

Thomas V.K., Andrew V.B., and N.N. John, 1983. Predicting Ship Performance in Level Ice, SNAME Transaction, Vol. 91, pp329~349.

Transportation Development Centre, 1995. Ship/Ice Interaction Database Version 1.0 User's Manual, Transportation Development Centre, May.

Tronin, V.A. and Y.A. Sandakov, 1977. Features of the Icebreaking Performance and Manoeuvrability of Icebreakers and Cargo Vessels on the Inland Waterways, Problemy Arktiki I Antarktiki, Leningrad, Vol. 50.

Tronin, V.A., et al., 1986. Investigation of Ice Navigation, Properties of Icebreakers, and Organization of icebreaking Operations in River Basins, IAHR Symposium on Ice, 8th, Iowa City, Aug. 18-22. Proceedings, Vol.2, p.87-99. United States.

Tue-Fee, K.K., 1985. Full Scale Maneuvering Tests in Level Ice of "Canmar Kigoriak" and "Robert LeMeur", presented at Arctic Section, SNAME, January 16. Canadian Marine Drilling Limited.

US Army CRREL, 1980. Analysis of the Performance of the 140 ft Great Lakes Icebreaker USCGC Katmai Bay, U.S. Army Cold Regions Research and Engineering Laboratory, 28p. United States. CRREL Report No: CR 80-08.

Valanto, P., 1997. On the Icebreaking Forces and Resistance of a Ship Advancing in Level Ice, International Conference on Offshore Mechanics and Arctic Engineering (OMAE), 16th, and International Conference on Port and Ocean Engineering Under Arctic Conditions (POAC), 14th, Yokohama, Japan, Apr. 13-17. Proceedings. Vol.4. Edited by H. Yamaguchi, K. Izumiyama, D.S. Sodhi, W.A. Nixon, and H. Kitagawa, p.63-71. New York, American Society of Mechanical Engineers. United States.

Valanto, P., 2001. On The Cause and Distribution of Resistance Forces on the Ship Hulls Moving in Level Ice, Proceedings - 16th International Conference on Port and Ocean Engineering under Arctic Conditions, Vol.16(Vol. 2), p.803-813, Ottawa, ON, Canada, Aug. 12-17. Edited by R. Frederking, I. Kubat and G.W. Timco. International Conference on Port and Ocean Engineering under Arctic Conditions. International.

Valanto, P., 2001, The Resistance of Ships in Level Ice, SNAME Transactions, Vol. 109, pp 53~83.

Vance, G.P., 1980. Supplementary Data for Analysis of the Performance of a 140 ft Great Lakes Icebreaker, USCGC Katmai Bay, CRREL Internal Report, No.CRREL IR-621 (unpaginated). U. S. Army, Corps of Engineers, Cold Regions Research and Engineering Laboratory, Hanover, NH, United States.

Vance, G.P., 1979. Characteristics of the ice on Whitefish Bay during January, February and March 1979, U.S. Army Cold Regions Research and Engineering Laboratory, 27p. United States. CRREL Report No: SR 80-32.

Vance, G.P., 1980. Characteristics of Ice in Whitefish Bay and St. Marys River During January, February and March 1979, Research and Development Center U.S. Coast Guard, Special Report 80-32.

Varges, G., 1987. Advances in Icebreaker Design - The Conversion of the Soviet Polar Icebreaker Mudyug into a Thyssen / Waas Ship, Thyssen Nordseewerke GmbH. 6th WEMT Symposium: Sommer Tagung, Travemünde, 2. bis 5. Juni 1987. ppA47-A71. West European Conference on Marine Technology.

Voelker, R.P., DeBord F.W., Goisel, F.A., Coburn, J.L., and K.E. Dane, 1981. Winter 1981 Trafficability Tests of the USGGC Polar Sea: Volume 1 - Main Report, Volume 2 - Environmental Data, Volume 5 - Bollard and Tow-Rope Pull Tests, Volume 6 - Analysis of Polar Class Level Ice Resistance, Volume 10 - Instrumentation System Description, Arctec Incorporated for Marine Administration, U.S. Department of Transportation, Report No. 583C-3, December 14.

Voelker, R.P., DeBord, F.W. and D.E. Dane, 1979. Executive Summary - SS Manhattan Arctic Marine Project, Report 100, ARCTEC Inc. Submitted to U.S. Maritime Administration, March.

Voelker, R.P., F.A. Geisel, 1984. Level Ice Resistance of USCGC Polar Sea in Antarctica, Arctec Incorporated for Marine Administration, U.S. Department of Transportation. Report No. 872C-2. May 10.

Voelker, R.P., Geisel, F.A., and K.E. Dane, 1982. Arctic Deployment of USCGC Polar Star - Winter 1982: Volume 1 - Executive Summary, Volume 2 - Environmental Data, Volume 3 - Trafficability, Level Ice and Pressure Ridges, Volume 5 - Instrumentation System and Computer Software Documentation, Arctec Incorporated for Marine Administration U.S. Department of Transportation, Report no. 730B, November 3.

Waclawek, P., 1997. Manoeuvres in Ice of CCGS Henry Larson Performed During 1997 Voyage to Voisey's Bay, NRC/IMD Report TR-1997-20, Institute for Ocean Technology, National Research Council of Canada, St. John's, NL.

Waclawek, P., Molyneux, D., and J. Woodward, 1998. Ship Maneuvring using the PMM: A Numerical Analysis, NRC/IMD Report LM-1998-18, Institute for Ocean Technology, National Research Council of Canada, St. John's, NL.

Wartsila Marine Inc., 1989. Type 1100 PAPA Trials - CCGS Ann Harvey, Wartsila Marine Inc. for Fleet Systems CCG.

Molyneux, W.D, and F.M. Williams, 1999. Ship Powering Performance in Multiple Layers of Broken Ice, Proceeding of OMAE99, 18th International Conference on Offshore Mechanics and Arctic Engineering, July 11-16, St. Johns, Newfoundland, Canada, pp1~9.

Williams, F.M., Spencer, D., Mathews, S.T., and I. Bayly, 1992. Full Scale Trials in Level Ice with Canadian R-Class Icebreaker, SNAME Transactions, Vol. 100, pp293~313.

Williams, F.M., Spencer, D., Parsons, B., Hackett, P., Gagnon, B., Everard, J., and S. Butt, 1991. Full-Scale Ice Breaker Trials CCGS Sir John Franklin Indian Arm/Little Burnt Bay 1991, NRC/IMD Report TR-1991-03, Institute for Ocean Technology, National Research Council of Canada, St. John's, NL.

Williams, F.M., Spencer, D., Mathews, S.T., and I. Bayly, 1992. Full Scale Trials in Level Ice with Canadian R-Class Icebreaker, NRC/IMD Report IR-1992-18, Institute for Ocean Technology, National Research Council of Canada, St. John's, NL.

Williams, F.M., Waclawek, P., and H-S. Kim, 1996. Simulation of Manoeuvring in Ice: IMD – Samsung Collaborative Project Status Report, NRC/IMD Report TR-1996-28, Institute for Ocean Technology, National Research Council of Canada, St. John's, NL.

Williams, F.M., and P. Waclawek, 1998. Physical Model Tests for Ship Manoeuvring in Ice, NRC/IMD Report IR-1998-08, Institute for Ocean Technology, National Research Council of Canada, St. John's, NL.

Yamaguchi, H., and H. Kato, 1994. Hydrodynamic Effect of Ship Advance on Ice Flexural Failure, International Offshore and Polar Engineering Conference, 4th, Osaka, Japan, Apr. 10-15. Proceedings. Vol.2. Edited by J.S. Chung, K. Karal, and W. Koterayama, p.592-595. Golden, CO, International Society of Offshore and Polar Engineers (ISOPE). United States.

Yamaguchi, H., Suzuki, Y., Uemura, O., and H. Kato, 1997. Influence of Bow Shape on Iceberaking Resistance in Low Speed Range, 16th, and International Conference on Port and Ocean Engineering Under Arctic Conditions (POAC), 14th, Yokohama, Japan, Apr. 13-17. Proceedings. Vol.4. Edited by H. Yamaguchi, K. Izumiyama, D.S. Sodhi, W.A. Nixon, and H. Kitagawa, p.51-61. New York, American Society of Mechanical Engineers. United States.